

User Manual

FG-200 HSE/FF Modbus



Disclaimer of liability

The information contained in these instructions corresponds to the technical status at the time of printing of it and is passed on with the best of our knowledge. Softing does not warrant that this document is error free. The information in these instructions is in no event a basis for warranty claims or contractual agreements concerning the described products, and may especially not be deemed as warranty concerning the quality and durability pursuant to Sec. 443 German Civil Code. We reserve the right to make any alterations or improvements to these instructions without prior notice. The actual design of products may deviate from the information contained in the instructions if technical alterations and product improvements so require.

Trademarks

FOUNDATION™ and HART® are marks of the FieldComm Group of Austin, Texas, USA.
Modbus® is a registered trademark of Schneider Electric, licensed to the Modbus Organization, Inc.

OpenSource

To comply with international software licensing terms, we offer the source files of open source software used in our products. For details see <https://opensource.softing.com/>

If you are interested in our source modifications and sources used, please contact: info@softing.com

Softing Industrial Automation GmbH

Richard-Reitzner-Allee 6
85540 Haar / Germany
<https://industrial.softing.com>

☎ + 49 89 4 56 56-340

✉ info.automation@softing.com
support.automation@softing.com

📄 <https://industrial.softing.com/support/support-form>

Scan the QR code to find the latest documentation on the product web page under Downloads.



Table of Contents

Chapter 1	About this guide	7
1.1	Read me first.....	7
1.2	Target audience.....	7
1.3	Typographic conventions.....	7
1.4	Document history.....	8
1.5	Related documentation.....	8
1.6	Document feedback.....	8
Chapter 2	About FG-200 HSE/FF Modbus	9
2.1	Intended use.....	9
2.2	Specifications.....	9
2.3	System requirements.....	9
2.4	Safety precautions.....	10
Chapter 3	Installation	11
3.1	Hardware installation.....	11
3.1.1	Installation in hazardous locations	11
3.1.1.1	General requirements.....	11
3.1.1.2	Hazardous Location - European and International Approval (ATEX, IECEx).....	13
3.1.1.3	Hazardous Location - North American Approval (cULus).....	14
3.1.2	Mounting and dismounting	15
3.1.3	Connection diagram	16
3.1.4	Connecting the power supply	16
3.1.5	Installation positions	17
3.1.6	Connecting to the network	19
3.1.7	Modbus serial connection	20
3.1.8	Using two FG-200	21
3.1.9	Connecting FF-H1 interfaces	22
3.1.10	Powering up the device	23
3.1.11	Adding a second FG-200 to form a redundant set of FG-200	23
3.2	Software installation.....	24
Chapter 4	Configuration	25
Chapter 5	Working with the FG-200 HSE/FF Modbus	26
5.1	FG-200 acts as a Modbus / FF-H1 Gateway.....	26
5.1.1	FG-200 acts as link active scheduler	26
5.1.2	FG-200 acts as visitor host	27

5.1.3	Configuring the Modbus mapping table	27
5.1.4	Modbus statistics counter	28
5.2	FG-200 acts as a FF-HSE/ FF-H1 gateway.....	29
5.2.1	FG-200 acts as an H1 interface used by Emerson AMS System	29
Chapter 6	Using the web interface.....	31
6.1	Login to webserver.....	31
6.2	Information.....	32
6.3	Diagnostics.....	33
6.3.1	System	33
6.3.2	Internet Protocol	33
6.3.3	Fieldbus	34
6.3.4	Advanced	34
6.4	Monitor	35
6.4.1	Point Pages	35
6.4.2	Point Data	35
6.5	Configuration.....	36
6.5.1	Settings	36
6.5.1.1	General Settings	36
6.5.1.2	Internet Protocol.....	38
6.5.1.3	LD Settings	39
6.5.1.4	User Accounts	39
6.5.2	System Maintenance	41
6.5.2.1	Restart	41
6.5.2.2	Firmware	41
6.5.2.3	Configuration Backup.....	42
6.5.2.4	Time	43
6.5.3	Page Options	44
6.5.3.1	Point Pages	44
6.5.3.2	Point Columns	45
6.5.3.3	Homepage	46
6.5.4	Fieldbus	47
6.5.4.1	Devices	47
6.5.4.2	Blocks	48
6.5.4.3	H1 Busparameter.....	49
6.5.4.4	HSE	49
6.5.5	Modbus	50
6.5.5.1	Communication	50

6.5.5.2	Import/Export	51
Chapter 7	Redundancy mode.....	52
7.1	Redundancy concept.....	52
7.2	Fault domain.....	53
7.3	Configuration of a redundant FG-200 pair.....	56
Chapter 8	LED status indicators.....	57
8.1	PWR - power supply.....	58
8.2	Device LED statuses in stand-alone mode.....	58
8.3	Device LED statuses in redundant mode.....	59
8.4	Status indications of the four H1 channels.....	61
Chapter 9	Appendix	62
9.1	FOUNDATION Fieldbus basics.....	62
9.1.1	Link active scheduler	62
9.1.2	Visitor host	62
9.1.3	Live list	62
9.1.4	Publisher/subscriber links (PUB/SUB links)	62
9.1.5	Client/server connections (CTL/SRV connections)	63
9.1.6	Macrocycle	63
9.1.7	Input/output parameters (I/O parameters)	63
9.1.8	Contained parameters	63
9.2	Redundancy.....	63
9.2.1	Redundancy behavior	64
9.2.1.1	Primary device failure (1).....	64
9.2.1.2	Ethernet cable broken (2).....	64
9.2.1.3	H1 cable broken (3).....	64
9.2.1.4	Secondary device failure (4).....	65
9.2.1.5	Ethernet cable broken (5).....	65
9.2.1.6	H1 cable broken (6).....	65
9.2.1.7	TCP connection lost (7).....	65
9.2.1.8	Redundancy link broken or removed (8).....	66
9.2.1.9	State indication associated.....	66
9.2.2	Duration of redundancy switch-over	68
9.2.3	Replace a defective FG-200 in a redundant set	69
9.3	Diagnostics - Advanced submenus.....	70
9.3.1	Fieldbus Statistics submenu	70
9.3.2	HSE Statistics submenu	70
9.3.3	FPGA Error Statistics submenu	71

9.3.4	FPGA Register Contents submenu	72
9.3.5	Device Temperature submenu	72
9.3.6	Modbus Statistics submenu	72
9.4	Coding of bit fields.....	74
9.5	Modbus exception responses.....	75
9.6	Assign a second (local) IP address under Windows 8.1.....	75
Chapter 10	ATEX Type Examination Certificate.....	76
Chapter 11	UL Certificate of Compliance.....	79
Chapter 12	Declarations of conformity.....	80

1 About this guide

1.1 Read me first

Please read this guide carefully before using the device to ensure safe and proper use. Softing does not assume any liability for damages due to improper installation or operation of this product.

This document is not warranted to be error-free. The information contained in this document is subject to change without prior notice. To obtain the most current version of this guide, visit the Download Center on our website at: <http://industrial.softing.com/en/downloads>

1.2 Target audience

This guide is intended for experienced operation personnel and network specialists responsible for configuring and maintaining field devices in process automation networks. Any person using a FG-200 HSE/FF Modbus must have read and fully understood the safety requirements and working instructions in this guide.

1.3 Typographic conventions

The following conventions are used throughout Softing customer documentation:

Keys, buttons, menu items, commands and other elements involving user interaction are set in bold font and menu sequences are separated by an arrow

Open **Start** → **Control Panel** → **Programs**

Buttons from the user interface are enclosed in brackets and set to bold typeface

Press **[Start]** to start the application

Coding samples, file extracts and screen output is set in Courier font type

`MaxDlsapAddressSupported=23`

Filenames and directories are written in italic

Device description files are located in *C:\<Application name>\delivery\software\Device Description files*



WARNING

WARNING indicates a hazardous situation which, if not avoided, may result in major problems or injury.



CAUTION

CAUTION indicates a potentially hazardous situation which, if not avoided, may result in minor or moderate problems or injury.



Note

This symbol is used to call attention to notable information that should be followed during installation, use, or servicing of this device.



Hint

This symbol is used when providing you with helpful user hints.

1.4 Document history

Document version	Changes since last version
1.00	First version
1.01	<ul style="list-style-type: none"> ▪ Installation in hazardous locations⁽¹¹⁾: <ul style="list-style-type: none"> - Introduction restructured and subsections implemented. - Preliminary information restrictions in hazardous locations deleted. - Certificate for cULus added⁽¹⁴⁾. ▪ New section with certificate copy of UL certificate UL Certificate of Compliance⁽⁷⁹⁾.
1.02	New Corporate Identity implemented.
1.20	References to FF-CONF replaced with comConf. Instructions to Modbus mapping and related chapters removed.
1.30	New layout and structure of chapters. Simplified mounting, dismounting and configuration instructions. Additional trademark references. Software installation procedure updated.
1.30.1	New image of power supply pin assignment ⁽¹⁶⁾ . Minor editorial changes.
1.30.2	RJ45 status LEDs ⁽⁵⁷⁾ explained.
1.30.3	Description of Modbus functionality ⁽¹⁹⁾ updated. Conformity of EX standards ⁽¹³⁾ updated.
1.30.4	CCCEX certificate added ⁽¹³⁾ .
1.30.5	Description on Modbus functionality updated.
1.30.6	Modbus configuration ⁽⁵⁰⁾ description updated.

1.5 Related documentation

The following documents provide additional product information:

- Communication Configuration Tool - User Guide
- FG-200 HSE/FF Modbus - Datasheet

1.6 Document feedback

We would like to encourage you to provide feedback and comments to help us improve the documentation. You can write your comments and suggestions to the PDF file using the editing tool in Adobe Reader and email your feedback to support.automation@softing.com.

If you prefer to write your feedback directly as an email, please include the following information with your comments:

- document name
- document version (as shown on cover page)
- page number

2 About FG-200 HSE/FF Modbus

The Softing FG-200 HSE/FF Modbus is a gateway connecting Modbus TCP or FOUNDATION fieldbus High Speed Ethernet (HSE) to FOUNDATION fieldbus H1 field devices. It provides fast access to process data, while making use of FOUNDATION Fieldbus advantages such as reduced cabling, central field device parametrization, comprehensive diagnostics or intrinsically safe device segments. For simple installation it is compatible with the R. STAHL bus-Carrier Series 9419 and Fieldbus power supplies Series 9412.

2.1 Intended use

The FG-200 can be used for integrating up to four FF H1 links into a Modbus control system or for communication between FF H1 devices and FF HSE network. The gateway can be operated in both hazardous and non-hazardous areas. Any other use is not intended. Follow the instructions in this guide on how to use the FG-200.

2.2 Specifications

Power supply	18 VDC...32 VDC; SELV/PELV supply mandatory Typical input current is 200 mA; maximum is 1 A (considering the rush-in current at switch-on).
FF-H1	Four FF-H1 channels, compliant with type 114 of the FF physical layer profile. The Fieldbus voltage range is from 9 VDC...32 VDC. Preferred value is 24 VDC.
Ethernet	IEEE 802.3 100BASE-TX/10BASE-T
Minimum ambient operating temperature	-40 °C (see Installation positions ⁽¹⁷⁾ for the maximum ambient temperature depending on the mounting position)
Storage temperature	-40 °C...+85 °C
Relative humidity	10 %...95 % (non-condensing)
Altitude	Must not exceed 2000 m
Location	Indoor use only; no direct sunlight
Coating	Conformal Coating based on ANSI/ISA-S71.04 G3
Safety standard	IEC/EN/UL 61010-1 Safety requirements for electrical equipment for measurement, control and laboratory use - Part 1: General requirements IEC/EN/UL 61010-2-201 Safety requirements for electrical equipment for measurement, control and laboratory use - Part 2-201: Particular requirements for control equipment (both with CB scheme).
Ingress protection	IP20

2.3 System requirements

- 24V power supply
- power conditioner
- PC with operating system Windows 7 or later (both 32 bit or 64 bit supported)
- Web browser (Microsoft Internet Explorer version 8.0 or higher, Mozilla Firefox version version 35 or higher)

2.4 Safety precautions

Use in hazardous areas

The FG-200 is an electrical equipment with degree of protection Ex ec, approved for use in Zone 2 hazardous areas or in the safe area. The four FF-H1 interfaces are designed according to the protection method Ex ic. Only certified circuits with an according protection method shall be connected to these FF-H1 interfaces.

Special hints for safe use



- Before setting the FG-200 into operation, the corresponding field has to be marked (e.g. if the device is used in an IC environment, mark the upper field on the type label).

IECEX BVS 15.0055 X
 Ex ec [ic] IIC T4 Gc
 Ex ec IIC T4 Gc

- Use an appropriate permanent pen for signing, e.g. an etching pen.
- More than one marking is not allowed. If you need a second marking, you must replace the existing equipment with a new one.
- An equipment which has been operated under non-intrinsically safe conditions is no longer permitted to be used under intrinsically safe conditions.

The FG-200 HSE/FF Modbus is only approved for intended and appropriate use. In case of noncompliance, the warranty and manufacturer’s liability do no longer apply!



CAUTION

During operation, the device's surface will be heated up. Avoid direct contact. When servicing, turn off the power supply and wait until surface has cooled down.



Note

Do not open the housing of the FG-200. It does not contain any parts that need to be maintained or repaired. In the event of a fault or defect, remove the device and return it to the vendor. Opening the device will void the warranty!

3 Installation

3.1 Hardware installation



Note

With an ambient temperature above 55 °C at the place of installation it is likely that the temperatures of connecting cables will increase if the cables are installed in an unfavourable position. In such cases, measure the temperature to ensure that the service temperature of the cables is not exceeded (i.e. 80 °C), or use cables sustaining high temperatures of at least 90 °C.

3.1.1 Installation in hazardous locations

The FG-200 may be used in hazardous locations and is certified according to ATEX, IEC and North America Approval cULus.



WARNING

Use only according to operating conditions from instructions! Use the FG-200 in accordance with its designated use only! Otherwise, the manufacturer's liability and warranty will expire. The device is only to be used according to the operating conditions described in these instructions..



WARNING

Do not connect or disconnect energized conductors! Be aware that energized conductors are not to be connected or disconnected! This can lead to danger of life if potentially explosive atmosphere is present there at that time!.

3.1.1.1 General requirements

Following general requirements must be observed while installing FG-200 on hazardous locations:

- The details of this document must be observed along with the conditions for use and the applicable details stated on the marking and type labels of each.
- Any selection and operation of the device must be done as per the technical rules.
- Adequate precautions must be taken to prevent unintended actuation or impairment of the device.
- Connectors must not be connected or disconnected when area is known to be hazardous. This can be life threatening in a potentially explosive atmosphere. Open or not securely closed sockets shall not be energized in the Ex-atmosphere!
- Ensure the installed equipment comply with the types of protection applicable to the corresponding zones.
- All connected electrical equipment must be suitable for the respective intended use.
- The operator must ensure protection against lightning in compliance with the locally applicable regulations.
- Electrostatic aspects must be considered when mounting the bus-modules. Electrostatic charges have to be prevented.

- In explosion group IIC and Zone 2 no protected plastic surfaces > 20 cm² are allowed; in IIB or dust-Ex, 100 cm² may be reached.
- The hazard of any objects falling onto the bus-module must be prevented.
- The FG-200 does not meet the requirements of impact protection and IP54 (according to IEC 60529). It must be installed in a protective enclosure which meets the requirements for resistance to impact and IP as stated in section 26.4 of IEC/EN 60079-0. This enclosure must be fully mounted and intact. If the enclosure is damaged, the operation is not permitted.
- Transient protection must be provided at a level not exceeding 140% of the peak rated voltage value at the supply terminals to the equipment.
- When removing the packaging ensure that no dirt can enter the enclosure or the plugs.
- If any vibration during the operation may cause parts of the plugs to loosen, then the plugs have to be provided with a light firm varnish used for securing screws. An extraction force of 0.5 Nm has to be achieved at an equivalent thread.
- To circuits of Zone 2 only such equipment may be connected that is suitable for operation in this zone and has been certified accordingly.
- Components may only be replaced by original spare parts which are also approved for the use in Ex-atmospheres. Spare parts are ordered as complete units giving the material number stated on the device (marking, type label).
- Only such auxiliary components may be used in potentially explosive atmospheres which meet all requirements of European and national directives and legislation.
- The environmental conditions specified in the manual have to be followed strictly.
- The FG-200 is not to be used in systems where cathodic systems for corrosion protection are in place. Although special precautions may allow the use in such systems (additional earthing bridges), the manufacturer has to be consulted in each case.
- The operator has to provide measures for protection against lightning.
- According to the local conditions and in compliance with the environmental rules, the operator is responsible to visually inspect the system and to remove dust settlements in a regularly interval (every 6 months).
- The company installing the device has to ensure that the transient characteristic is limited to 40% above the service voltage.
- Additional precautions have to be taken, if the presence of hydrosulfide, ethylene oxide and/or carbon monoxide is to be expected: those substances are of a vary low ignition energy.
- Icing is not permitted.

Pair of values for fieldbus voltage and current for Intrinsic Safety Fieldbus (ic):

	Pair 1	Pair 2	Pair 3
Fieldbus Voltage	U _i = 14 Volt DC	U _i = 17.5 Volt DC	U _i = 32 Volt DC
Fieldbus Current	I _i = 570 mA	I _i = 319 mA	I _i = 100 mA

**CAUTION**

Make sure that the sum of power supply voltage and fieldbus supply voltage does not exceed 60 VDC!

**Explosion hazard**

Do not disconnect equipment unless power has been removed or the area is known to be non-hazardous.

**Observe relevant national regulations, standards and directives**

This manual does not supersede the relevant national regulations, standards and directives. These must be observed and have to be applied according to the national conditions!

3.1.1.2 Hazardous Location - European and International Approval (ATEX, IECEx)

The equipment has been assessed as based on the following standards and editions:

- a) EN IEC 60079-0:2018
- b) IEC 60079-11:2011 Ed. 6 + Corr. 2012 / EN 60079-11:2012
- c) EN IEC 60079-7:2015+A1:2018

If indicated on the device label or by technical documentation, the FG-200 is suitable for use in gas-Ex atmospheres of Zone 2 in the explosion groups IIA, IIB and IIC in temperature class T4, if accommodated in a tested enclosure.

- IECEx BVS 15.0055 x marking for explosion protection: Ex ec IIC T4 Gc, Ex ec [ic] IIC T4 Gc
- BVS 15 ATEX E 063 X marking for explosion protection:  II 3G

The Ex protection method [ic] corresponds only to the FF-H1 fieldbus interfaces.

The FG-200 HSE/FF Modbus complies with the applicable standards and regulations and meets the requirements of Directive 2014/35/EU. The requirements for erecting the device as part of the system in potentially explosive atmospheres (e.g. IEC / EN 60079-14) must be strictly adhered.

Certificates

- ATEX** The EC type examination number for ATEX is: **BVS 15 ATEX E 063 X**
A copy of the certificate is available in section [ATEX Type Examination Certificate](#)⁷⁶.
- IECEX** The type examination number for IECEX is: **IECEX BVS 15.0055X**
The certificate can be downloaded from the [product website](#).
- CCCEX** The certificate can be downloaded from the [product website](#).

3.1.1.3 Hazardous Location - North American Approval (cULus)

If indicated on the device label, the FG-200 is suitable for use in Class 1, Division 2, Groups A, B, C and D hazardous or non-hazardous locations.

The device must be installed in a protective enclosure which meets the requirements for resistance to impact and IP54 according to IEC 60529.

Marking for explosion protection: Class I Div.2 Groups A,B,C,D.

Certificate

- cULus** The cULus Certificate of Compliance number is: **20151215-E356500**
A copy of the certificate is available in section [UL Certificate of Compliance](#)⁷⁹.

3.1.2 Mounting and dismounting



Note

Make sure the FG-200 HSE/FF Modbus is mounted in such a way that the power supply can be easily disconnected.



Note

Depending on the installation position, the maximum ambient operating temperature may differ. See Section [Installation positions](#) ⁽¹⁷⁾ for details.



Installation and inspection

Installation and inspection must be carried out by qualified personnel only (personnel qualified according to the German standard TRBS 1203 - Technical Regulations for Operational Safety). The definition of terms can be found in IEC 60079-17.

Mounting

1. Hook the upper notch of the cut-out on the back of the FG-200 HSE/FF Modbus into a 35 mm DIN rail.
2. Press the FG-200 HSE/FF Modbus down towards the rail until it slides into place over the lip of the locking bar.

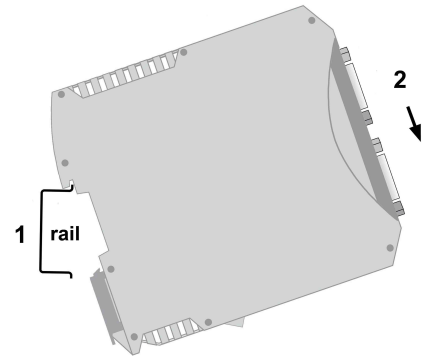

Note

Do not put stress on the system by bending or torsion.

Dismounting

1. Slide a screwdriver diagonally under the housing into the locking bar.
2. Lever the screwdriver upwards, pull the locking bar downwards - without tilting the screwdriver - and move the gateway upwards off the rail.

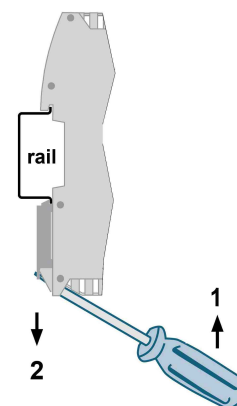

3.1.3 Connection diagram

The following connection diagram shows the physical interfaces of the FG-200.

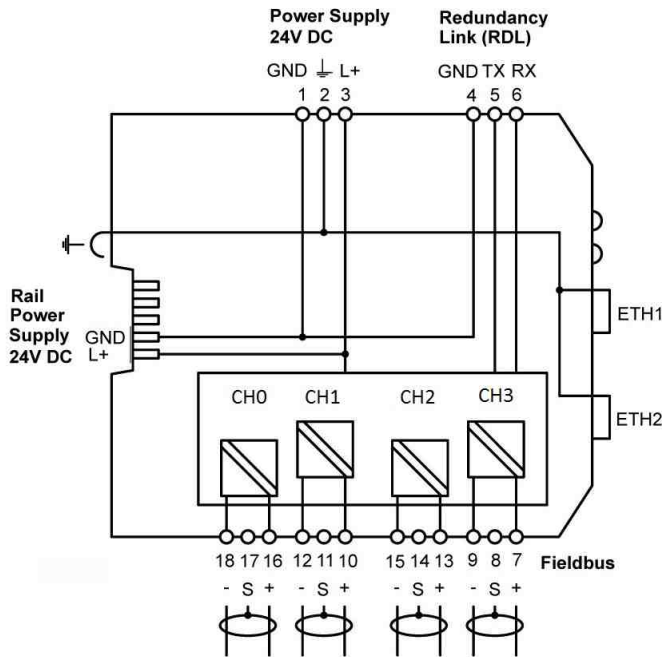

3.1.4 Connecting the power supply

1. Connect the FG-200 to a 24 V DC power supply.
2. Use different or redundant power supplies for redundant FG-200s.
3. Turn on the power supply. The boot process takes approx. 50 seconds. For indication of proper operation of a FG-200 acting in non-redundant mode or as primary device in redundant mode refer to [LED status indicators](#) ⁽⁵⁷⁾.

The supply voltage (18 VDC 32 VDC) is connected by a 3-pole terminal block. The power supply is connected to the plug connector via flexible wires with a cross section of 0.75 to 1.5 mm². The ground connection wire must have a cross section of 1.5 mm².

Pin	Signal	Description
1	GND	Ground
2		Functional earth
3	L+	Positive supply voltage



CAUTION

The Functional Earth (FE) connection of the device has to be connected at low inductance with the Protective Earth (PE) of the system.



Note

As indicated in the connection diagram, the power can be applied alternatively by a special DIN rail connector (Rail Power Supply). For further information contact Softing Industrial Automation.

3.1.5 Installation positions

The FG-200 HSE/FF Modbus can be mounted horizontally and vertically. Depending on the installation position, different ambient operating temperatures (T_a) are allowed.



Minimum distance

Provide a minimum distance of 50 mm to the air inlet and air outlet to ensure natural convection.



Rotated installation position

The maximum permissible ambient temperature values also apply to a 180° rotated installation position.

Horizontal installation position

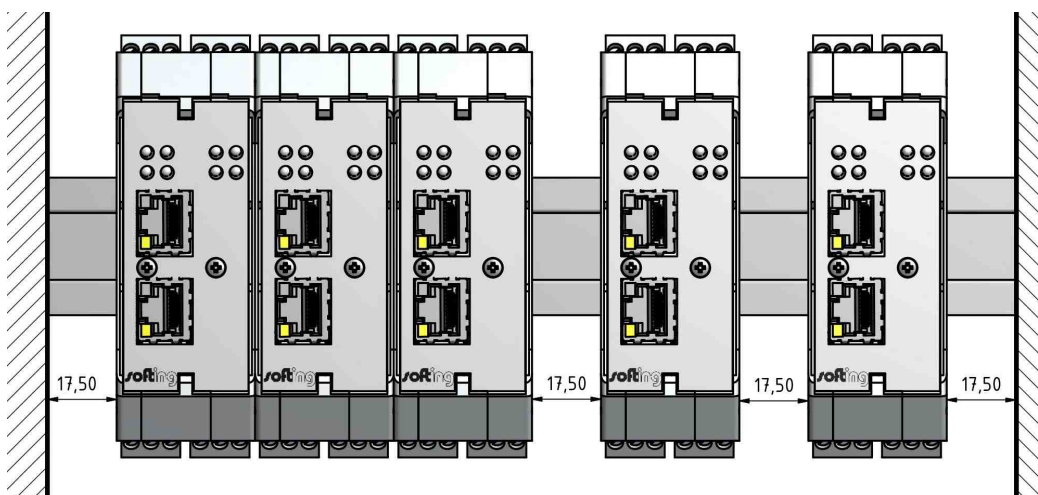

Maximum ambient temperatures for the FG-200 HSE/FF Modbus

Number of PA channels used	Maximum fieldbus voltage	Minimum distance	Maximum permissible ambient temperature T_a
4	32VDC	0 mm	55 °C
2	24VDC	0 mm	60 °C
4	32VDC	17.5 mm	65 °C
2	24VDC	17.5 mm	70 °C

Vertical installation position

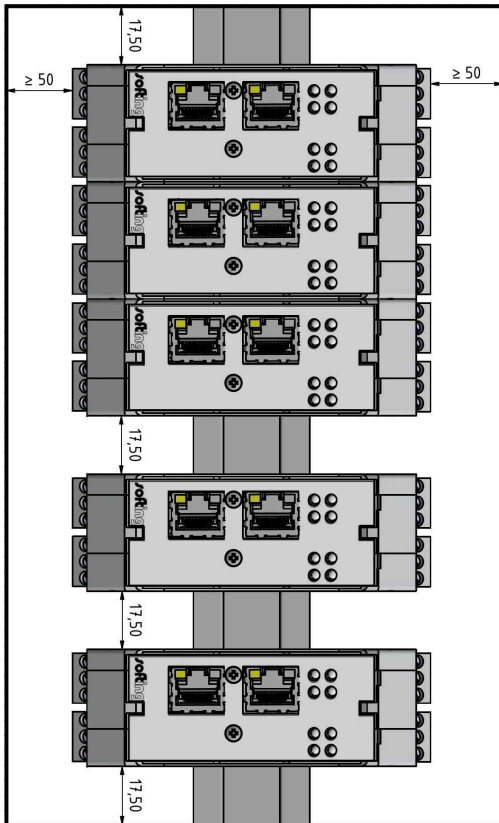

Maximum ambient temperatures for the FG-200 HSE/FF Modbus

Number of PA channels used	Maximum fieldbus voltage	Minimum distance	Maximum permissible ambient temperature T _a
4	32VDC	0 mm	40 °C
2	24VDC	0 mm	50 °C
4	32VDC	17.5 mm	55 °C
2	24VDC	17.5 mm	60 °C

3.1.6 Connecting to the network

1. Connect the FG-200 to the Modbus TCP network to one of the two Ethernet ports (ETH1 or ETH2).
2. Connect each link of your FOUNDATION fieldbus H1 network via a power conditioner to a Fieldbus Channel port of your gateway (CH0 to CH3).



Note

When using the FG-200 as linking device you can broadcast High Speed Ethernet (HSE) and Modbus TCP over the same Ethernet port.

FG-200 with redundancy connection

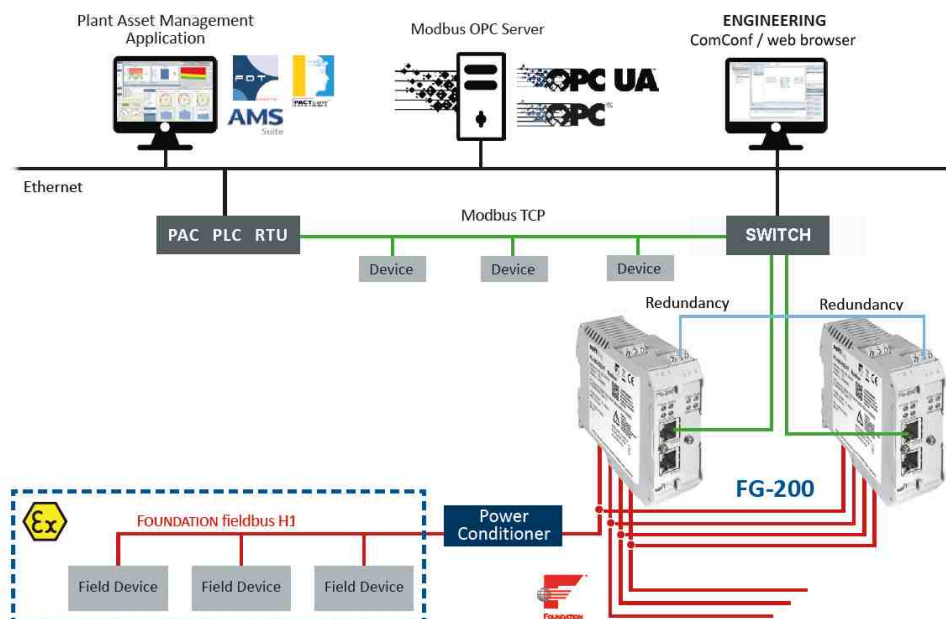

FG-200 without redundancy connection

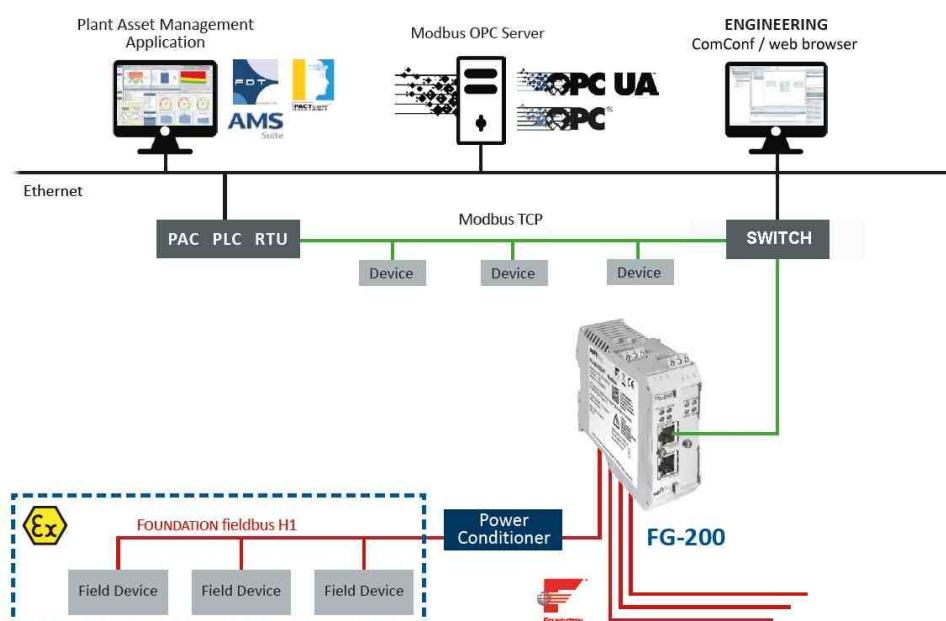

3.1.7 Modbus serial connection

When connecting the FG-200 via serial connection use the connector from your delivery with the following pin assignment:

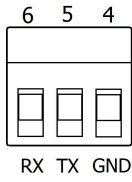

Pin No.	Signal	Connector symbol
6	RX	+
5	TX	S
4	GND	-



Note

If you are working with two FG-200 in redundant mode, the serial connection cannot be used, refer to [Use two FG-200s as a redundant set](#)⁽²¹⁾.

3.1.8 Using two FG-200

If you intend to use two FG-200 as a redundant set, connect the redundancy link interfaces (RDL) of both FG-200 (primary and secondary) by a cable before you power up the devices. If the redundancy link is not installed before start-up, the FG-200 will operate in non-redundant mode.



Note

As the interface is not galvanically isolated make sure that there is no potential difference between the two connected devices.

The maximum cable length is 0.5 m according to EMC requirements. The pin assignment is:

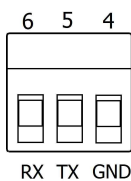

Pin	Signal	Description
6	RX	Receives data from redundant device
5	TX	Transmits data to redundant device
4	GND	Ground



Note

The receive (RX) and transmit (TX) signals must be cross-linked.

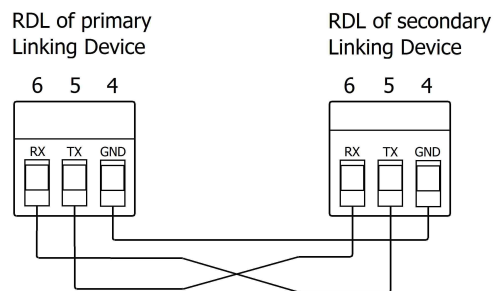

Do not power up devices when serial link is missing

If the two FG-200 forming a redundant set are powered while the serial link is missing, both devices will behave like independent, non-redundant Primary Devices. If they operated in redundant mode before and therefore have identical configuration information, both will use the same H1 node addresses, which will cause problems on the H1 links. The ERR (error) LED will blink. In this case, remove the power, install the serial link and apply the power again.

Primary device vs. secondary device

When using a redundant set of two FG-200, the device which is powered first will operate as primary device. If both devices are powered at the same time, the one with the lower IP address will operate as primary device.

Removing the power supply

Before you remove the power supply from the primary device make sure the secondary device is operational. In a redundant set of FG-200, removing the power supply, the Ethernet cable or the redundancy link interface cable from the primary device causes a redundancy change-over. Before doing so, make sure that the secondary device is operational (and not still booting due to a prior change-over). Otherwise the system breaks down or the configuration information might get lost. Therefore wait at least one minute between such checks.

3.1.9 Connecting FF-H1 interfaces

Connect the H1 links to the terminal blocks of the H1 interfaces. Since the FG-200 does not provide power to the H1 links, a power conditioner and a bus termination is required for each H1 link. When using a redundant set of two devices, make sure to connect each H1 link to the same channel (CH 1 .. CH 4) on both FG-200s.

The FG-200 provides four Foundation Fieldbus H1 interfaces. These interfaces are named CH1 to CH4 and are used to connect an FF-H1 bus to the FG-200.

FF H1 bus line channel 1

CH1

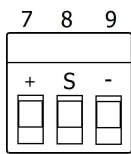

Pin	Signal	Description
7	+	Fieldbus +
8	S	Fieldbus shield
9	-	Fieldbus -

FF H1 bus line channel 2

CH2

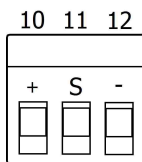

Pin	Signal	Description
10	+	Fieldbus +
11	S	Fieldbus shield
12	-	Fieldbus -

FF H1 bus line channel 3

CH3

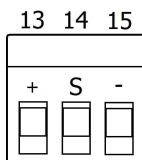

Pin	Signal	Description
13	+	Fieldbus +
14	S	Fieldbus shield
15	-	Fieldbus -

FF H1 bus line channel 4

CH4

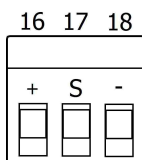

Pin	Signal	Description
16	+	Fieldbus +
17	S	Fieldbus shield
18	-	Fieldbus -



Note

The fieldbus shield is not connected directly to functional earth. For EMC reasons, it is only connected via a capacitor. If a direct connection to functional earth or protective earth is required, you need to implement this separately.

3.1.10 Powering up the device

Turn on the power supply. The boot process takes a few seconds. For indication of proper operation of a FG-200 refer to [LED status indicators](#)⁽⁵⁷⁾.

3.1.11 Adding a second FG-200 to form a redundant set of FG-200

For adding a second FG-200 to an already commissioned FG-200 that is operating in the role "Primary, no backup", the following steps are required:

1. Set the IP configuration (IP address and subnet mask) of the second FG-200 using the same IP subnet as the primary device (see [Configuration](#)⁽²⁵⁾).
2. Connect the H1 links to the terminal blocks of the H1 interfaces. Make sure to connect each H1 link to the same channel (CH 1 .. CH 4) on both FG-200s.
3. Connect the second FG-200 to the Ethernet switch or hub.
4. Connect both RDL interfaces as mentioned in Section [FG-200 redundancy](#).⁽²¹⁾
5. Connect the second FG-200 to a 24 V DC power supply. Use different or redundant power supplies for redundant FG-200s.
6. After turning on the power supply the boot process takes approx. 50 seconds.
7. The second FG-200 will take over the configuration data from the primary device and will start operation in the role "secondary". For more details about proper operation as a secondary device see also the [LED status indicators](#)⁽⁵⁷⁾.



Hint

Refer to Section [FG-200 redundancy](#)⁽²¹⁾ for more information on the redundancy concept.

3.2 Software installation

When you install a Softing product for the first time, you will be asked if you trust the publisher. Activate the option **Always trust software from Softing AG** if you do not want to be asked in subsequent installations and select **[Install]** to start the installation.

1. Go to the [FG200 product page](#) to download the latest product software.
2. Start by downloading and installing the **Search and Configure** tool.
3. Follow the on-screen installation instructions.
4. Read the license agreement carefully.
If you have questions, you can **[Cancel]** the installation at this point and contact us. Click **[Print]** if you want to print the license agreement to a PDF or on a printer.
5. Select **I accept the terms in the license agreement** and click **[Next]**.
6. Click **[Install]** to install the selected software application on your PC.
While the installation is in progress, the status bar of the installation wizard shows the different steps that are being executed. If you want to abort the installation, click **[Cancel]** button. The installation wizard will undo all modifications that have been made to your computer up to this point. Otherwise, wait until the installation is completed.
7. Press **[Finish]** to complete the installation and exit the wizard.



Note

Proceed with the installation of the other software packages.

Additional installations

Depending on your use case, install one of the following software packages:

- Install the FDT frame application **PACTware** if you are using FDT technology. The PACTware package includes the communication DTM **FFdtm**.
- Install **FFdtm** if you prefer using a different FDT frame application such as FieldCare, FieldMate or others to allow using a CommDTM in another FDT frame application.
- Install **Communication Configuration Tool** (comConf) for a complete network configuration.

4 Configuration

The FG-200 is delivered with the pre-configured IP address 192.168.0.10.



Note

Before connecting the FG-200 to your LAN network, make sure that its IP address is not used by another network station. To assign a new IP address to your PC, you must have administrator rights.

1. Open a browser (e.g. Internet Explorer or Firefox).
2. Enter the URL address **192.168.0.10** and press **Enter**.
3. Login with the following data:
login name: **administrator**
login password: **fgadmin**
4. Select **Configuration** → **Settings** → **Internet Protocol**.
5. Change **IP Address** and **Subnet Mask**.
6. Click [**Change Settings and Reboot**].

Configuration > Settings > Internet Protocol

Change Settings	
Obtain an IP Address from a DHCP Server	<input type="radio"/>
Specify an IP Address	<input checked="" type="radio"/>
Hostname	FG200-FF/HSE Modbus
IP Address	172.17.210.109
Subnet Mask	255.255.0.0
Default Gateway	172.17.0.160

Change Settings and Reboot Read Current Values

7. The FG-200 performs a reboot.

5 Working with the FG-200 HSE/FF Modbus

5.1 FG-200 acts as a Modbus / FF-H1 Gateway

Main purpose: PLC with Modbus interface accesses IO parameters of FF-H1 field devices

FG-200 supports access to IO parameters of FF-H1 field devices via [client/server connections](#)⁶³ (CLT/SRV connections) and via [publisher/subscriber links](#)⁶² (PUB/SUB links).

When accessing device IO parameters it is not possible to mix CLT/SRV connections and PUB/SUB links. For the selection of the communication mode see below.

5.1.1 FG-200 acts as link active scheduler

If FG-200 acts as a [link active scheduler](#)⁶², no other FF host system is connected to the H1 segment.

For accessing field device parameters CLT/SRV connections as well as PUB/SUB links can be used. PUB/SUB links are the standard way for accessing IO parameters in FF installations. If you want to use PUB/SUB links, you have to configure them using the configuration tool comConf. For more information see the Configuration Communication Tool User Guide.

As there is no other FF host system you have to download the function block schedule into the field devices. You can generate the function block schedule and download it to the field devices by means of comConf.

Before you go online with the comConf update your general settings in the FG-200's web interface. Go to **Configuration → Settings → General Settings**:

Configuration > Settings > General Settings

General Settings	
Enable automatic VCR Creation	<input checked="" type="checkbox"/>
Display Blocks	<input type="checkbox"/>
Enable HSE Alarms	<input type="checkbox"/>
Link Master Functionality	<input checked="" type="checkbox"/>
Visitor Mode	<input type="checkbox"/>
Enable Modbus	<input type="checkbox"/>

If you have changed your settings click **[Change Settings]** to apply the new values. For more configuration details, see the Configuration Communication Tool User Guide.

5.1.2 FG-200 acts as visitor host

In this case the FG-200 is connected to an H1 segment that is controlled by another FF host system. The links between the FF field devices and the FF host system are working. The FG-200 is not allowed to disturb the operation by reconfiguring working communication paths.

The FG-200 is just allowed to use CLT/SRV connections for reading [contained parameters](#)⁶³ and function block output parameters. The parameters to be read have to be configured in the Softing Configuration Communication Tool (comConf). See the [comConf User Guide](#) for more details.



Important Note

If the FG-200 acts as a visitor host, no comConf project must be downloaded into the FG-200 and the field devices.

Parameter settings

- Make sure **Enable automatic VCR Creation** is activated.
- Activate or deactivate **Link Master Functionality** depending on the following presumptions:

For this scenario we recommend configuring the Node Address within the range from 252 to 255 for the FG-200. If you want prevent the FG-200 to take an active role in the H1 segments, deactivate **Link Master Functionality**. Usually this is not required if the H1 bus parameters used in the control system are not too slow.

If **Link Master Functionality** is activated make sure that all activated H1 links of the FG-200 are connected to H1 segments with an active host system interface. Otherwise the FG-200 would wait for a 6 minute period for activity on the H1 segments and would then disable the segments without activity i.e. the segments without an active host interface.

5.1.3 Configuring the Modbus mapping table

The FG-200 supports the mapping of a set of function block parameters to Modbus registers. The set of available parameters depends on the type of communication (PUB/SUB links or CLT/SRV connections) used for transferring IO data.

The FG-200 selects PUB/SUB links or CLT/SRV connections depending on the downloaded comConf project.

Perform mapping on the web server application

Prerequisite: You have downloaded the comConf project.

1. Open the web browser and login.
2. Go to **Configuration → Fieldbus → Blocks** and click **[Reload Live List]**.
3. Select **Configuration → Fieldbus → Devices**.
4. Load the .csv file with the Modbus mapping. Select **Configuration Modbus Mapping Import/Export**. Click **[Import]** and load the file generated by comConf.

Mapped values are now accessible in the configured Modbus registers and can be accessed by a Modbus control.

5.1.4 Modbus statistics counter

You can get additional statistic information concerning the Modbus communication state by reading the Modbus registers:

Modbus Holding Register (add. base 0)	Modbus Holding Register (add. base 1)	Meaning
9000	9001	Redundancy Role: 0: Primary 1: Secondary
9001	9002	Number of received Modbus TCP requests
9002	9003	Number of sent Modbus TCP responses
9003	9004	Number of received Modbus TCP requests with encoding errors
9007	9008	Number of current open Modbus TCP sessions
9008	9009	Total number of Modbus TCP sessions
9009	9010	Timestamp for starting Modbus TCP statistic collection
9010	9011	Time stamp for starting Modbus TCP statistic collections



Note

Statistic values from Modbus registers 9001 – 9010 are identical to information available in the menu: **Diagnostics** → **Advanced** → **Modbus Statistics** → **TCP** and **Diagnostics** → **Advanced** → **Modbus Statistics** → **Serial**.

Statistic counter values can be reset via web menu.

5.2 FG-200 acts as a FF-HSE/ FF-H1 gateway

5.2.1 FG-200 acts as an H1 interface used by Emerson AMS System

Emerson provides its AMS Device Manager for calibration, diagnostics and device configuration for various fieldbus technologies. Using the FG-200 enables AMS Device Manager to access FF-H1 devices. As a precondition it is necessary to enable FF-HSE interface in the AMS Device Manager and integrate the FF device descriptions of the FG-200 (CFH-File) and the H1 Devices that have to be accessed.

In order to use the FG-200 the following general settings have to be done via the webserver interface:

Configuration > Settings > General Settings

General Settings	
Enable automatic VCR Creation	<input checked="" type="checkbox"/>
Display Blocks	<input type="checkbox"/>
Enable HSE Alarms	<input type="checkbox"/>
Link Master Functionality	<input checked="" type="checkbox"/>
Visitor Mode	<input type="checkbox"/>
Enable Modbus	<input type="checkbox"/>

Configuration > Settings > LD Settings

Linking Device Settings	
PD Tag	FG200_For_AMS_Interface
Link ID 1 (Range 0,1000-FFFF)	1000
Link ID 2 (Range 0,1000-FFFF)	1001
Link ID 3 (Range 0,1000-FFFF)	1002
Link ID 4 (Range 0,1000-FFFF)	1003
Node Address (Range 16-247,252-255)	16

Make sure **Enable automatic VCR Creation** is activated. Otherwise no access to H1 device parameters would be necessary.

Additional settings depend on the user scenario:

Offline access (Standalone network FG-200 and H1 devices)

In this scenario the FG-200 would be the primary host device and **Link Master Functionality** is activated. In addition we recommend disabling the **Visitor Mode** and setting Node Address to 16 or 17. Make sure all required H1 Links are activated i.e. a Link ID \geq 0x1000 is assigned for those links.

Access in field (H1 devices are used as part of a control system)

For this scenario we recommend configuring the Node Address within the range from 252 to 255 for the FG-200. If you want prevent the FG-200 to take an active role in the H1 segments, deactivate **Link Master Functionality**. Usually this is not required if the H1 bus parameters used in the control system are not too slow.

If **Link Master Functionality** is activated make sure that all activated H1 links of the FG-200 are connected to H1 segments with an active host system interface. Otherwise the FG-200 would wait for a 6 minute period for activity on the H1 segments and would then disable the segments without activity i.e. the segments without an active host interface.

H1 Device Alarms

AMS Device Manager supports monitoring a subset of H1 device alarms. To make use of this functionality you need to enable this feature in the AMS Device Manager and to configure the FG-200 and the attached H1 devices accordingly. Note that within AMS Device Manager alarms are designated as "Alerts". Activate this setting with **Enable HSE Alarms** in the General Settings web menu of the FG-200.

We recommend activating **Visitor Mode** in the **General settings** web page. Thus you disable the alarm configuration of H1 devices. This would prevent an impact on an existing device configuration but could lead to situations where it is not possible to receive alarms from some H1 devices. To display which devices are affected go to **Configuration → Fieldbus → Device** and search in column "Alarm configured" for the respective device.

AMS Device Manager is supporting standard Fieldbus Foundation alarm messaging using the UDP protocol, but it has an preconfigured UDP multicast address (239.255.0.33) and UDP port (45000) for the reception of the alarm messages. This is used as default in the FG-200 but could be altered if a future AMS Device Manager version would expect a different multicast address or UDP port by changing the settings in the following web menu.

Configuration > Fieldbus > Advanced > Network Parameters > HSE

Settings	
Alarm Distribution Address	239.255.0.33
Alarm Distribution Port	45000

6 Using the web interface

After an IP connection between PC and FG-200 has been set up as described in [Configuration](#)²⁵, you may access the FG-200 from your PC by means of a web browser that supports JavaScript (e.g. Microsoft Internet Explorer).

The internal web server of the FG-200 offers the possibilities to configure the device (such as IP address settings or Modbus mapping), to get diagnostic information on the fieldbus or Modbus as well as to monitor process values of the connected field devices.

6.1 Login to webserver

1. Start your web browser with the URL <http://192.168.0.10>.
You are prompted to log in with username and password.
2. Enter **administrator** in the field **Username**.
3. Enter **fgadmin** in the **Password** field (default setting - refer also to [Settings - User Accounts](#)³⁹).
The start page is opened - in our example the Information page (refer to [Homepage submenu](#))⁴⁶.
Depending on the web browser you are using the information presentation may vary slightly:



The menu bar on the left side offers three main menus and several submenus:

- [Information menu](#)³²
- [Diagnostics menu](#)³³
- [Monitor menu](#)³⁵
- [Configuration menu](#)³⁶



Note

If you erase the FG-200 configuration, the password is reset to its default value.

6.2 Information

The **Information** menu offers the following menu items:

Menu item	Functionality
Contact	<p>shows the Softing contact information in case</p> <ul style="list-style-type: none"> ▪ you require general information about the product or ▪ you need technical support or ▪ you like to provide feedback about the product. <p>Softing Industrial Automation GmbH Richard-Reitzner-Allee 6 85540 Haar / Germany Tel: + 49 89 4 56 56-0 Fax: + 49 89 4 56 56-488 Internet: http://industrial.softing.com Email: info.automation@softing.com Support: support.automation@softing.com</p>
Version	<p>gives you detailed information about the device/system, the base module (mother board) and the H1 module (daughter bard) with the four H1 channels.</p> <p>Both modules as well as the entire device are identified by hardware version numbers and serial numbers. The firmware version and the system id, a manufacturer-specific identifier for the system, are also indicated.</p>
Manual	<p>provides access to information on how to use the web server. Click [Device Manual] to open the FG-200 HSE/FF Modbus User Manual.</p>
Notices	<p>informs you about the open Source Declaration and the open source software packages used in conjunction with FG-200 HSE/FF Modbus.</p> <p>Open Source Declaration: The FG-200 HSE/FF Modbus uses the following open source software packages:</p> <ul style="list-style-type: none"> ▪ - eCosPro V3.1.41 ▪ - jQuery V1.7.2 <p>The license declarations and links to source codes for these components are available on the following webpage: http://opensource.softing.com/IA/FG-200FF/V1/</p>

6.3 Diagnostics

6.3.1 System

Click **System** to display system information about the operating system and the hardware status:

- Operating State: operational, good, ...
- System Uptime: Time elapsed since the FG-200 has been booted.
- Memory load: Percentage of memory used.

Diagnostics > System

Operating System	
Operating State	Good
System Uptime	4d 23h 28m 49s
Hardware State	
Memory Load	8
Flash Load	26

6.3.2 Internet Protocol

Click **Internet Protocol** to display detailed information about the addresses used:

MAC Address: number that acts like a name for the network adapter

IP Address: IP address of the FG-200

IP Address (redundant device):

IP address of the redundant FG-200. Empty if the FG-200 operates in non-redundant mode.

Subnet Mask: IP subnet mask

Default Gateway: Address of the IP gateway to other subnets

Redundancy State: Current role in a redundant set of FG-200; the following values are possible

- Primary, no backup
- Primary
- Secondary

Diagnostics > Internet Protocol

Internet Protocol	
MAC	00:06:71:2d:00:1a
IP Address	172.17.11.26
IP Address(redundant Device)	Not detected
Subnet Mask	255.255.0.0
Default Gateway	0.0.0.0
Redundancy State	Primary, no backup

6.3.3 Fieldbus

Fieldbus segment diagnostics are provided to give you a quick view of what is attached to the FG-200. It shows how many segments are active. Two tables are displayed: The first table shows the information about the FG-200, the PD Tag as well as the Device ID. The PD Tag can be modified in the [LD Settings submenu](#)⁽³⁹⁾ page. The second table shows which segment (H1 Link) of the FG-200 is occupied and how many FF-H1 devices are connected to each segment. Additionally, for each available FF-H1 device the tag name is shown. This table provides a simple live list of the FF-H1 network. To update this list click the **Fieldbus** menu again.

System and Segment status in detail:

- PD Tag (Physical Device Tag): a unique, configurable and system-dependent name for the device.
- Device ID is set to a unique value for each individual device by the device manufacturer.
- Online: indicates whether a device is online or not.
- Devices: shows number of devices online (including the FG-200).

For each FG-200 up to four H1 Links (segments) are available. And under each H1 Link up to 16 H1 devices are possible.

The following example shows that in segment 1 the FG-200 plus four field devices are online and in segment 3 the FG-200 plus five field devices are online. In the segments 2 and 4 only the FG-200 is online.

Diagnostics > Fieldbus

PD Tag	FG200_Modbus108			
Device ID	1E6D114210-00-FG200-000150400108			
Description	Segment 1	Segment 2	Segment 3	Segment 4
Online	✔	✔	✔	✔
Devices	5	1	6	1

6.3.4 Advanced

The Advanced submenu contains additional statistics information. Refer to [Diagnostics - Advanced submenus](#)⁽⁷⁰⁾ in the Appendix for a detailed description of the different web menus.

6.4 Monitor

6.4.1 Point Pages

Point Pages displays the output of FF function blocks (value and status) on one or more web pages. Multiple pages can be configured to fit the application and to keep track of the different parts of the plant.

Click **Point Pages** to select the desired part of data. It may be displayed in one or more rows or sites.

pointpage_0 ▾

Segment	Device	Block	Block Desc	Parameter	Point	Name	Description	Value	Status	Description	Status	StatusIcon
4	SoftingDevice2	MAI		MAI .OUT_1	MAI .OUT_1			892.109985	Good	NonCascadeNonSpecific	Good	🟢
4	SoftingDevice1	AI		AI .OUT	AI .OUT			87.000000	Good	NonCascadeUnacknowledgedAdvisoryAlarm	Good	🟢
4	SoftingDevice1	DI		DI .OUT	DI .OUT			0x00	Good	NonCascadeNonSpecific	Good	🟢



Hint

The initial value in column "StatusDescription" is shown offline until a value has been received after the first call-up of this point page.

If a device to which this point page value has been assigned is not online, the text "Unknown Device" in column "Device" is displayed and in "StatusDescription" appears "Offline" for this specific point.

In this case check whether the H1 devices configuration has been changed. Perform a Reload Live List as described in [Blocks submenu](#)⁴⁸.

6.4.2 Point Data

Click **Point Data** to display all data items from all point pages.

Segment	Device	Block	Block Desc	Parameter	Point	Name	Description	Value	Status	Description	Status	StatusIcon
4	SoftingDevice2	MAI		MAI .OUT_1	MAI .OUT_1			814.109985	Good	NonCascadeNonSpecific	Good	🟢
4	SoftingDevice1	AI		AI .OUT	AI .OUT			9.000000	Good	NonCascadeUnacknowledgedAdvisoryAlarm	Good	🟢
4	SoftingDevice1	DI		DI .OUT	DI .OUT			0x00	Good	NonCascadeNonSpecific	Good	🟢

6.5 Configuration



Note

Settings performed on the web interface are not automatically transferred from the primary to the secondary FG-200. The secondary FG-200 must also be configured separately.

6.5.1 Settings

6.5.1.1 General Settings

Configuration > Settings > General Settings

General Settings	
Enable automatic VCR Creation	<input checked="" type="checkbox"/>
Display Blocks	<input checked="" type="checkbox"/>
Enable HSE Alarms	<input checked="" type="checkbox"/>
Link Master Functionality	<input checked="" type="checkbox"/>
Visitor Mode	<input type="checkbox"/>
Enable Modbus	<input checked="" type="checkbox"/>

Change Settings

Enable automatic VCR Creation

If this feature is activated, the FG-200 establishes the VCR connection by itself.

Examples:

- Softing Communication Configuration Tool ComConf: activate
- Emerson AMS™ Software: activate
- NI-FBUS Configuration Tool: deactivate



Note

The feature **Enable automatic VCR Creation** has to be activated when the tool comConf is to be used for the Foundation fieldbus configuration.

Display Blocks

This feature enables or disables the [point page](#)³⁵ functionality.



Hint

The use of the point pages creates a lot of traffic of the FF-H1 network. If you do not use this Monitor feature then you can save more H1 bandwidth and faster reaction time over Modbus.

Enable HSE Alarms

The FG-200 is able to use the already configured alarm VCRs in the FF-H1 devices or can established new ones. Or it will configure the FF-H1 devices accordingly. The behavior depends whether the Visitor Mode is enabled or not.

Link Master Functionality

In case of visitor mode it can make sense to disable the Link Master functionality. If no Link Master is available on a segment connected to an activated H1 Link of the FG-200, a timeout will occur after 6 minutes to indicate this. The FG-200 will not be visible in the HSE live list during this period. To avoid this assure that a Link Master is present for all activated H1 Links or deactivate H1 Links of the FG-200.

Visitor Mode

When the FG-200 is in visitor mode it can be connected to a running FF-H1 network with the FF-Host system without affecting the established communication.

Enable Modbus

This button enables or disables Modbus TCP.

6.5.1.2 Internet Protocol

The FG-200 is delivered in a default configuration. To change the default internet protocol settings to assigned values of the chosen subnet in which the installation is running, select **Configuration**, then **Internet Protocol**.

A table enabling you to change settings appears.

1. Click **Obtain an IP address from a DHCP server** for a random address chosen from the DHCP server. To find out the IP address of the FG-200 you can use the function **Network Livelist** in the comConf tool (available from the Softing download area).
2. Alternatively, specify an IP Address to activate the fields in the table below:
 - Host name: configurable name for the host
 - IP Address: must be compatible with the subnet you choose for the PC setting, must be present in any case.
 - Subnet mask: default with 255.255.0.0, no change needed, must be present in any case.
 - Default Gateway: It is not necessary to configure a Default Gateway if the host and FG-200 share the same network.

Change Settings	
Obtain an IP Address from a DHCP Server	<input type="radio"/>
Specify an IP Address	<input checked="" type="radio"/>
Hostname	FG200-FF
IP Address	172.17.210.109
Subnet Mask	255.255.0.0
Default Gateway	172.17.0.160

3. Click **[Change Settings and Reboot]**
 The web site shuts down and the system reboots. The input values are checked for consistency. In case of problems the following error may be displayed:
 Failure: Wrong IP Settings.
 The FG-200 reboots after a few seconds and the new values are accepted.
 If you change the IP address of the FG-200, the IP connection between PC and FG-200 is lost. You have to use the new IP address to re-establish web access to the FG-200.
 If all parameters are correct, the new values are accepted and displayed.
4. **[Read Current Values]**
 If you changed some of the parameters and you are not sure of your changes, click the button **[Read Current Values]**. Input fields which are already filled are shown again.

6.5.1.3 LD Settings

In the LD Settings submenu you can change the:

- PD-Tag of the FG-200
- Link ID
- Node Address of the H1 links

Each FG-200 uses a default PD tag that includes the serial number. The default PD Tag is also used if the configuration is erased via the web server interface or during firmware download.

Configuration > Settings > LD Settings

Linking Device Settings	
PD Tag	FG210_DE109
Link ID 1 (Range 0,1000-FFFF)	0000
Link ID 2 (Range 0,1000-FFFF)	0000
Link ID 3 (Range 0,1000-FFFF)	0000
Link ID 4 (Range 0,1000-FFFF)	1000
Node Address (Range 16-247,252-255)	16

Change Settings

6.5.1.4 User Accounts

This menu allows you to change and confirm account passwords depending on the role. Due to the tasks a user executes in this web site there are several graduations for admission control. The following standard logins and passwords are available.

Role	Login name	Password
Administrator	administrator	fgadmin
Service or maintenance engineer	maintenance	keepitgoing
User or operator	operator	runit
Executive	executive	showme

These passwords can be configured with administrator rights in the following window:

Configuration > Settings > User Accounts

Change Password	
New Administrator Password	<input type="text"/>
Confirm	<input type="text"/>
New Maintenance Password	<input type="text"/>
Confirm	<input type="text"/>
New Operator Password	<input type="text"/>
Confirm	<input type="text"/>
New Executive Password	<input type="text"/>
Confirm	<input type="text"/>

Change Password

Enter the password into the corresponding field(s), confirm your entry and click **[Change Password]** to confirm the modified password(s).

The following tasks can be executed by the specified role:

Task	Administrator	Maintenance	Operator	Executive
Configure network settings	<input checked="" type="checkbox"/>			
Set passwords	<input checked="" type="checkbox"/>			
Set time settings and home page options	<input checked="" type="checkbox"/>			
Restart applications	<input checked="" type="checkbox"/>			
Monitor process values	<input checked="" type="checkbox"/>	<input checked="" type="checkbox"/>	<input checked="" type="checkbox"/>	<input checked="" type="checkbox"/>
Monitor diagnostic values	<input checked="" type="checkbox"/>	<input checked="" type="checkbox"/>	<input checked="" type="checkbox"/>	<input checked="" type="checkbox"/>



Note

Be careful when changing the administrator password. If you lose your changed administrator password, you cannot perform any configuration or set up task.

6.5.2 System Maintenance

6.5.2.1 Restart

In this submenu you can:

- Click **[Restart Now]** to restart the system.

6.5.2.2 Firmware

In this submenu you can:

- Erase an existing firmware configuration.
- Select new firmware file(s).

Configuration > System Maintenance > Firmware

Download Firmware and Reboot	
Erase Configuration	<input type="checkbox"/>
Select Firmware	<input type="text"/>

Download Firmware and Reboot



Do not activate the check box **Erase Configuration** unless you want to set up the complete plant configuration using the comConf tool. When activating, the PD tag is set to an empty string and all passwords are reset to standard passwords (refer to [Login to webserver](#)⁽³¹⁾ for more information).

1. Click **[Browse]** right beside the **Select Firmware** field and browse to your firmware file.
2. Confirm with **[Open]**.
3. Click **[Download Firmware and Reboot]** to download the firmware file and to reboot the system. The system performs a firmware file check. The download is started. Messages indicate the current download status. A complete download is indicated as successful and the FG-200 reboots:

Starting FW download, please don't power off the Linking Device.

```
Decoding Firmware File... OK, decoded 1897284 bytes
Firmware: "FG-200 Firmware VX.XX.0.00.socevatest"
Erasing Flash... OK, programming Flash... OK
Now Updating Backup Image
Erasing Flash... OK, programming Flash... OK
Erasing Configuration... OK
Success: Update Complete!
Rebooting... OK
```



Note

Do not access the web server of the FG-200 before the "Success" message is displayed in the browser window. If you do so, you will have to clear the cache of your web browser after the boot process has finished, and then re-establish a connection to the web server of the FG-200.

The end of the boot process is indicated by a continuously lit RUN LED for a FG-200 acting in non-redundant mode or for a primary device in redundant mode. For a secondary device it is indicated by a flashing (1 Hz) RUN LED.

6.5.2.3 Configuration Backup

In this submenu you can

- Restore a selected system configuration
- Save a selected configuration
- Erase the current configuration

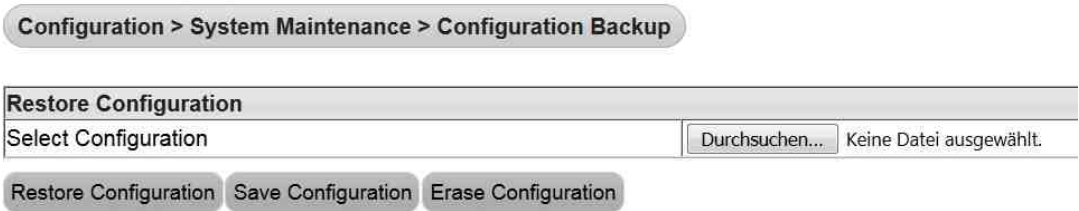

Restore Configuration

To restore a previously saved configuration click **[Browse]**, select the desired configuration file and confirm with **[Open]**.

Save Configuration

1. To save your current configuration, click **[Save Configuration]**. An additional window is opened asking you to save the file.
2. Click **Save file** and confirm with **[OK]**. The configuration file is saved to your standard download directory.

Erase Configuration

Click **[Erase Configuration]** to erase an existing configuration and to reset the FG-200 to factory default settings.



Note

When clicking **[Erase Configuration]** this causes the current configuration (without IP configuration) to be deleted. All passwords will be deleted and will be reset to their default value.

6.5.2.4 Time

In this submenu you can:

- Synchronize date and time between PC and device(s).
- Set a specific date and time for your device.

Configuration > System Maintenance > Time

Current Time	
Your PC's Time	Fri Aug 28 2015 13:43:52 GMT+0200
FG-200 FF Time	Sat Jan 01 1972 01:11:21 GMT+0100
Difference	-1377689551 seconds

Set Time	
Time Synchronized by HSE SNTP Server	Not configured
Set with PC	<input checked="" type="radio"/>
Manual Entry	<input type="radio"/>
Date (mm/dd/yyyy)	
Time (hh:mm:ss)	

Set Time



Note

If an SNTP server is configured, you cannot modify date and time due to automatic time synchronization.

The **Current Time** window frame shows the

- current time on your PC
- time on the Softing FG-200 and
- difference between the current PC time and the time on the FG-200.

In the **Set Time** window frame you can synchronize the current PC time and the time of the FG-200.

1. Select the radio button **Set with PC**.
2. Click **[Set Time]**.
The synchronized time will appear in the table.
If the FG-200 is connected to a network and if you want to use this feature, you can select a timeserver at your facility or one near you geographically to ensure accurate time adjustments. The device will function properly with this feature disabled but data time stamps are less accurate and time updates must be entered for each FG-200
3. Alternatively, select the radio button **Manual Entry**.
4. Click in the corresponding field **Date** and **Time** and enter the desired values.
5. Confirm your changes by clicking **[Set Time]**.
Your entries are now activated.

6.5.3 Page Options

6.5.3.1 Point Pages

Using the Point Pages you may view the output of a Function Block and its status in one or more web pages. You may also create select information of your entire plant. Multiple pages can be configured to fit the application.

Click **Point Pages** to display the current list of Point Pages.

Configuration > Page Options > Point Pages

Save Changes New Point Page

Name	Up	Down	Delete	Edit
pointpage_0			Delete	Edit
pointpage_1			Delete	Edit
pointpage_2			Delete	Edit

- [Save Changes]** Saves your changes.
- [New Point Page]** Inserts a new point page line (ascending number, maximum of 20 pages) .
- Up** and **Down** Sorts the selected page in the order you desire (up or downwards).
- [Delete]** Deletes the selected page.
- [Edit]** Allows you to edit the selected point page content. A new windows is displayed.

Configuration > Page Options > Point Pages

Point Page: pointpage_0

Save Changes New Point Switch to PP Overview

Point	Name	Description	Up	Down	Delete
MAI .OUT_1					Delete
AI .OUT					Delete
DI .OUT					Delete

You can insert a new point with **[New Point]**, edit the selected point, sort the list and delete the point.

Columns and their meaning

Point Lists the Blocks with OUTPUT parameters (e.g. AI, DI, PID, AO.BKCAL_OUT, AO.BKCAL_OUT). To open the list of configured points click on the arrow right beside the point. Depending on the selection for usage of cyclic communication (in **Configuration → General Settings**) the list will contain only those parameters that are configured to be published cyclically. Maximum number of new points is 20.

Name	Contains the parameter name. You can enter any name such as a plant or system tag name for an I/O parameter. Maximum length is 32 characters.
Description	Contains the user description of the parameter name.
[Save Changes]	Saves your changes. To display the new or modified values click [Switch to PP Overview] .
[Switch to PP Overview]	Switches back to the main point pages overview window.

6.5.3.2 Point Columns

The point columns submenu opens a table allowing you to activate various point columns to build the specific point page format. Activate the required column to make it appear in the point page:

Columns	Enable / Disable
Segment	<input checked="" type="checkbox"/>
Device	<input checked="" type="checkbox"/>
Block	<input checked="" type="checkbox"/>
Block Description	<input checked="" type="checkbox"/>
Parameter	<input checked="" type="checkbox"/>
Point	<input checked="" type="checkbox"/>
Name	<input checked="" type="checkbox"/>
Description	<input checked="" type="checkbox"/>
Value	<input checked="" type="checkbox"/>
Point Status	<input checked="" type="checkbox"/>
Status Description	<input checked="" type="checkbox"/>
Status Icon	<input checked="" type="checkbox"/>

Set Point Columns

Any deselected point column is disabled and does not appear in the point page (refer also to [Point Pages](#)³⁵ in the **Monitor** menu).

6.5.3.3 Homepage

The homepage submenu opens a table allowing you to set the start page of the FG-200 HSE/FF Modbus web interface to one of the following four pages:

- Information - Contact
- Diagnostics - Fieldbus
- Monitor - Point Monitor
- Monitor - Point Pages

Configuration > Page Options > Home Page

Set Homepage			
Information > Contact	<input checked="" type="radio"/>		
Diagnostics > Fieldbus	<input type="radio"/>		
Monitor > Point Monitor	<input type="radio"/>		
Monitor > Point Pages	<input type="radio"/>		pointpage_0

Set Homepage

Select the desired homepage and confirm your selection with **[Set Homepage]**. The next time you log in into your web interface it is opened with the new start page.

If you select **Monitor > Point Pages** you need to select the specific point page you want to be opened from a list.

6.5.4 Fieldbus

6.5.4.1 Devices

The devices submenu opens a table displaying the devices that are connected to the FG-200. The table shows which segment from the FG-200 is connected to how many devices. The devices are displayed with their H1 Node Address, their Device ID and their PD Tag.

Precondition: You have activated **Enable HSE Alarms** in **Configuration** → **Settings** → **General Settings**.

Additionally there is information about the alarm VCR (VCR address) and the status of the alarm (alarm sending in the H1 device and transferring the alarm from the FG-200 to HSE).

The column Alarm VCR displays the configured H1 endpoint address used for the reception of the alarms.

- ✔ indicates that alarm sending is configured.
- ✘ indicates that no alarm could be configured or - in Visitor mode only - a different endpoint is configured already to the device which must not be overwritten.

Configuration > Fieldbus > Devices

Segment	Node	Device ID	PD Tag	Alarm VCR	Alarm Configured
4	21	1E6D1100FF_____FBK__110703104	SoftingDevice1	0x27f	✔
4	22	1E6D110C00 FBK2__110703011	SoftingDevice2	0x27f	✔

Update Alarm VCR

Last Update: Fri Sep 18 2015 10:12:00 GMT+0200

The fields **Node** and **PD Tag** are display fields and cannot be modified.

Click [**Update Alarm VCR**] to update the list, e.g. after a configuration download. Thus, modified node addresses, PD tags or the communication configuration list will reflect the current H1 segment configuration status. Alternatively you can restart the FG-200 to update settings.

6.5.4.2 Blocks

The Block submenu displays the block information of all FF-H1 field devices that are connected to the FG-200. Two filters allow for selecting

Segment the list of configured segments.

Device list of devices connected.

The table shows the corresponding Block Type, Block Name, Description and whether it is enabled or not. Enabled block types are displayed in the point page in the [Monitor menu](#)³⁵. By default only those blocks are enabled that have a block name. For vendor-specific blocks the profile number is displayed instead of the name.

When naming blocks (up to 32 ASCII-characters) we recommend assigning self-explanatory names that contain information about the location or type (e.g. analog output, digital input).

Configuration > Fieldbus > Blocks

Segment: 4 Device: 1E6D1100FF FBK_110703104

Block Type	Block Name	Description	Enable
Resource Block V2	RB2		<input checked="" type="checkbox"/>
Profile: 0x8001	32769		<input checked="" type="checkbox"/>
Profile: 0x8002	32770		<input checked="" type="checkbox"/>
Profile: 0x8003	32771		<input checked="" type="checkbox"/>
Profile: 0x8004	32772		<input checked="" type="checkbox"/>
Analog Input	AI		<input checked="" type="checkbox"/>
Analog Input	AI_1		<input checked="" type="checkbox"/>
Analog Output	AO		<input checked="" type="checkbox"/>
Analog Output	AO_1		<input checked="" type="checkbox"/>
Discrete Input	DI		<input checked="" type="checkbox"/>
Discrete Output	DO		<input checked="" type="checkbox"/>
PID	PID		<input checked="" type="checkbox"/>

Set Tag Reload Live List Last Update: Fri Sep 18 2015 10:12:01 GMT+0200

[Set Tag] changes the block tag in the device according to the modifications performed.



Note

If you are working with the configuration tool comConf we recommend **not** to modify tags.

[Reload Live List] updates information on the blocks and reloads the live list in the comConf with updated information, e.g. after a configuration download. Thus, modified block tags will reflect the current configuration status. Alternatively you can restart the FG-200 to update information on the blocks.

6.5.4.3 H1 Busparameter

The H1 Busparameter submenu allows to define parameters for the chosen segment (H1 Link). Click **[Change Settings]** to apply your modifications and download it to the FG-200. If the selected H1 segment is active, the settings would also be downloaded to a secondary FG-200 if the FG-200 is acting as primary in a redundant set.

Configuration > Fieldbus > H1 Busparameter

1 ▾

Change Settings	
Node Address	16
Primary Link Master	<input type="checkbox"/>
First Unpolled Node	37
Number of Unpolled Nodes	186
Slot Time	8
Max. Response Delay	10
DLPDPU PHL Overhead	3
Min. Inter-PDU Delay	16
Apply Settings to all Segments	<input type="checkbox"/>

Change Settings

6.5.4.4 HSE

The HSE submenu allows to specify the **Alarm Distribution Address** and the **Alarm Distribution Port**. These parameters are the Multicast Address and the UDP Port that are used by the FG-200 to forward alarms from H1 devices.



Note

The default settings "Address = 239.255.0.33" and "Port = 45000" are required for interoperability with Emerson AMS tool.

Changing these parameters may disable the display of alarm conditions in AMS alert monitoring.

If a different HSE host tool is used, the parameter could be adapted to the values required by that tool.

Click **[Change Settings]** to apply your modifications.

Configuration > Fieldbus > Advanced > Network Parameters > HSE

Settings	
Alarm Distribution Address	239.255.0.33
Alarm Distribution Port	45000

Change Settings

6.5.5 Modbus

The FG-200 allows traditional control systems access to H1 fieldbus devices over Modbus TCP.

6.5.5.1 Communication

The Communication submenu allows to configure the Modbus Communication settings.



Hint

Before you modify settings make sure that the Modbus function is enabled and all parameters are set to a valid value. Therefore consult the manual of your particular Modbus client and adjust the Modbus configuration accordingly.

For Modbus TCP the communication settings (baud rate, parity, stop bits) can be ignored.

Click **[Change Settings]** to apply your modifications.

Settings	
One Modbus Address	<input type="radio"/>
Single Address	0
Multiple Modbus Address	<input checked="" type="radio"/>
Modbus TCP Port	502
Baud Rate	19200
Parity None	Even
Stop Bits	1
Response Delay Time	0
Unmapped Register Read Response	Illegal Data Address
Unmapped Register Write Response	Illegal Data Address
Write Behaviour	Queued
Floating Point Representation	Float
Use Swapped Floating Point Format	No
Incorporate Values Associated Status As Error	Yes
Value Reported For Error (Floating Point)	NaN
	0
Value Reported For Error (Rounded and Native Integer)	0
Stale count limit	4
Scaled Floating Point Maximum Integer Value	65534
Gain value used for scaled representation	1
Offset value used for scaled representation	0

Change Settings

6.5.5.2 Import/Export

In this submenu you can import a Modbus mapping created by comConf.

**Note**

The Modbus mapping table cannot be specified by the user any longer. You are currently importing a Modbus mapping created by the Softing ComConf.

[Export] Saves the imported Modbus Mapping table.

[Import] Imports an existing Modbus Mapping table in csv format.

Import CSV File	
Select CSV File	<input type="button" value="Durchsuchen..."/> Keine Datei ausgewählt.
<input type="button" value="Import"/>	<input type="button" value="Export"/>

7 Redundancy mode

Redundancy mode is possible in all environments/use cases where the FG-200 acts as link active scheduler.

Redundancy mode is not possible when FG-200 acts as a visitor host or when the serial RS232 interface of the FG-200 is used for Modbus communication.

7.1 Redundancy concept

FOUNDATION fieldbus is a distributed control architecture that provides increased availability compared to centralized control architectures.

To improve the availability of the FG-200 HSE/FF Modbus, it is possible to combine two FG-200 which then form a redundant Linking Device:

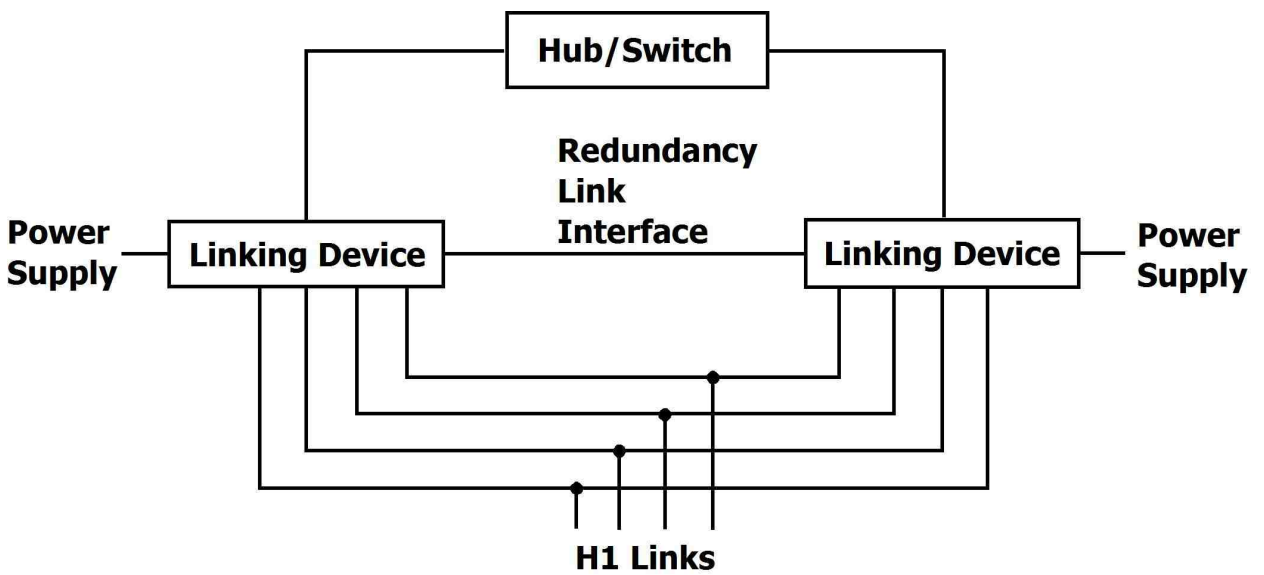

A redundant Linking Device (also called "a redundant set of devices") consists of two physical Linking Devices that are connected to the same HSE subnet and to the same H1 links. The redundant set of devices behaves like one logical Linking Device. By duplicating the physical Linking Device, it is possible to tolerate one fault in one of the two devices.

In a redundant set of devices one Linking Device acts as primary device and performs actively all communication functions, including the Link Active Scheduler (LAS) function on the H1 links. In a redundant set it is the primary device that has to be addressed by Hosts and configuration tools.

The second Linking Device, named secondary device, acts as backup device. It receives automatically the same configuration as the primary device, but uses different node addresses on the H1 links and a different IP address on HSE.

The secondary device is able to take over the function of the primary device if the primary device fails. In that case the Linking Device is reduced to a non-redundant system that is not able to tolerate any further failure. Therefore it is necessary to replace the defective device as soon as possible to recover redundancy.

The secondary device acts as Backup Link Master on each H1 link attempting to take over the LAS role if required. Additional Link Master Devices may be configured to act as Backup Link Master on the H1 links.

The two devices forming a redundant set communicate via a redundancy link interface and via Ethernet. The serial line is used to establish a redundant set of devices, to exchange signs of life, and to control redundancy switch-over, while the Ethernet is used to transfer configuration information from the primary device to the secondary device. Therefore an operational serial communication path and an operational Ethernet path between both devices are required for proper operation.

The two physical Linking Devices forming a redundant set of devices are determined by the serial link between them. Without that serial link, both devices operate like independent, non-redundant Primary Devices.

7.2 Fault domain

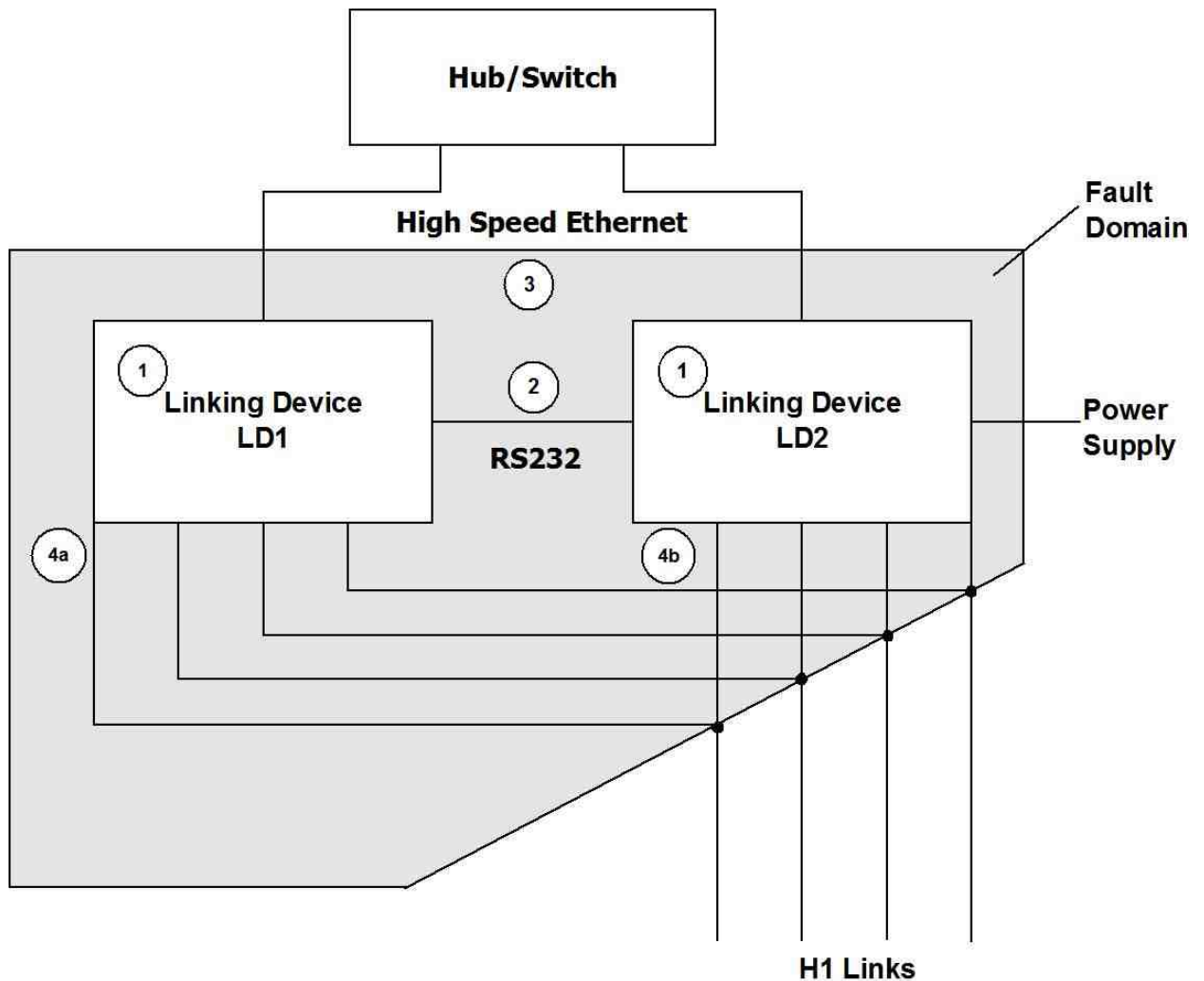

The shaded area in the figure above shows the fault domain. Faults within the fault domain can be detected and covered by the redundancy features. Those are:

- permanent faults within the Linking Device - (1)
- transient faults within a Linking Device that lead to loss of functions - (1)
- a loss of the serial connection between the two Linking Devices - (2)
- a failure in the Ethernet communication between the two Linking Devices - (3)

- a loss of an H1 connection between the primary device and the entire H1 link; this may be caused by disconnecting an H1 cable from the primary device - (4a) if LD1 acts as primary device; (4b) if LD2 acts as primary device).

Detecting a loss of an H1 connection between the primary device and the entire H1 link requires that at least two H1 devices have been connected to that H1 channel of the Linking Device and have appeared in the H1 Live List before the loss of the connection occurs.

Only one of the listed faults may be present at a time. Another fault cannot be tolerated until the redundant set has been repaired and a fully operational secondary device is available.

The following fault conditions cannot be detected and covered:

- A loss of an H1 connection between the primary device and a subset of devices on an H1 link
- A loss of an H1 connection between the secondary device and the entire H1 link or a subset of devices on an H1 link.

The conditions for a switch-over from the primary device to the secondary device are listed below.

Transfer from primary device to secondary device

The primary device transfers its role to the secondary device

- if** Host system or configuration tool request to transfer the role
- or** the primary device detects a failure of its own Ethernet port
- or** the primary device detects a failure on at least one H1 interface
- or** the primary device detects a loss of the connection to all devices on an H1 link.¹

¹ This requires that at least two devices have been connected to that H1 channel of the Linking Device and have appeared in the H1 Live List before the loss of the connection occurs.

The secondary device accepts the transfer

- if** its H1 interfaces are operational and faultless
- and** its Ethernet port is operational
- and** it has a valid configuration.

Take over of primary role

The secondary device takes over the primary role

- if** the serial connection to the primary device is lost
- and** it acts as Link Active Scheduler on all configured H1 links
- and** its Ethernet port is operational.

Restoring redundancy

Only one of the listed faults may be present at a time. Another fault cannot be tolerated until the redundant set has been repaired and a fully operational secondary device is available.

The required measures for repairing the redundant set of devices depend on the present fault. For an overview refer to Table 15.

Fault	Measure of repair
Permanent fault within the FG-200	Replacement of the defective FG-200.
Transient fault within the FG-200	Restart of the FG-200 (performed automatically).
Loss of the serial connection between the two FG-200s	Re-establishment of the serial connection.
Loss of the Ethernet connection between the two FG-200s.	Re-establishment of the Ethernet connection.
Loss of an H1 connection between the Primary Devices and the entire H1 link	Re-establishment of the H1 connection.

7.3 Configuration of a redundant FG-200 pair

Webserver interface

Make sure that both FG-200s have a different IP address. Refer to Chapter [Configuration](#)²⁵ for a detailed description.

After modifying the configuration settings click [**Change Settings**] to apply the new settings and to reboot the FG-200. Make sure to apply these configuration settings on **both** FG-200s.

Detect primary and secondary FG-200

To detect primary and secondary FG-200 go to **Diagnostics** → [Internet Protocol](#)³³. In the respective entry in line **Redundancy State** you will see **Primary, no backup** for the primary device and **Secondary** for the secondary device.

Then go to **Diagnostics** → [Fieldbus](#)³⁴ and note down the **Device ID** for the respective FG-200.

comConf

1. To configure a redundant FG-200 with the comConf select the FG-200 within the project manager or topology and open the Properties View.
2. Enter the IP address in the corresponding fields of the secondary FG-200.
3. Save the values with Ctrl+S.
4. From the **Build** menu select the command **Build All** (or press **Alt+F8**).
5. Generate Code for the current segment.
6. Select **Download** → **Download Project**.

Synchronize Modbus mapping tables

To synchronize Modbus mapping tables of primary and secondary device, import the mapping tables generated with comConf in both the primary and secondary FG-200.

8 LED status indicators

The FG-200 displays eight device status LEDs and two RJ45 connection status LEDs on the front side:

Device status LEDs

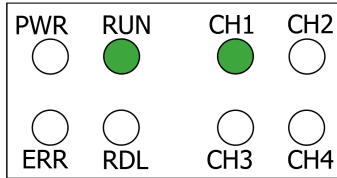

RJ45 status LEDs

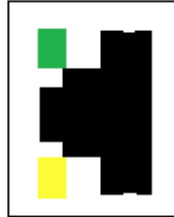

- PWR** = power supply - refer to [PWR - power supply](#) ⁽⁵⁸⁾
- RUN** = running - refer to [Device LED statuses](#) ⁽⁵⁸⁾
- ERR** = error- refer to [Device LED statuses](#) ⁽⁵⁸⁾
- RDL** = redundancy link - refer to [LED statuses in redundant mode](#) ⁽⁵⁹⁾
- CH1 to CH4** = H1 channel 1 to H1 channel 4 - refer to [Status indications of the four H1 channels](#) ⁽⁶¹⁾



The device status LEDs are permanently on or flash in different colors and frequencies as indicated below:

Symbol	Color	Lighting
	none	off
	red	permanent
	green	permanent
	red	flashing
	green	flashing
	green	flashing slowly (0.5 Hz)
	green	flashing quickly (5 Hz)

The RJ45 status LEDs indicate the following behaviour:













Symbol	Color	Lighting
	green	permanent when Ethernet connection is on
	yellow	flashing when Ethernet connection is active

8.1 PWR - power supply

	permanent green	24V DC power supply is ok
	off	no power supply



8.2 Device LED statuses in stand-alone mode





























































The following table shows possible LED combinations in stand-alone mode:









































































LEDs		Meaning	
PWR   ERR	green 	RUN   RDL	Start-up phase (approximately 7 seconds) During this phase redundancy role is determined.
PWR   ERR	green 	RUN   RDL	Non redundant device, ready. The device is operational; it is not part of a redundant set.
PWR   ERR	green red 	RUN   RDL	Permanent hardware fault detection during startup. A fatal error has been detected.

8.3 Device LED statuses in redundant mode

The redundancy link LED is used to indicate if traffic via the serial line is performed. It will flash green if a valid message is received. It will switch to red if serial communication is lost and it will be off if no serial response has been received after startup.







	flashing green	redundancy link communication is ok (triggered by redundancy link packets)
	red	link communication interrupted or aborted (broken down)
	off	no link communication at all

LEDs	Meaning																
<table border="1"> <tr> <td>PWR</td> <td></td> <td>RUN</td> <td></td> </tr> <tr> <td></td> <td>green</td> <td></td> <td></td> </tr> <tr> <td></td> <td></td> <td></td> <td></td> </tr> <tr> <td>ERR</td> <td></td> <td>RDL</td> <td></td> </tr> </table>	PWR		RUN			green							ERR		RDL		<p>Start-up phase (approx. 7 seconds)</p> <p>During this phase redundancy role is determined.</p>
PWR		RUN															
	green																
																	
ERR		RDL															
<table border="1"> <tr> <td>PWR</td> <td></td> <td>RUN</td> <td></td> </tr> <tr> <td></td> <td>green</td> <td></td> <td>green</td> </tr> <tr> <td></td> <td></td> <td></td> <td></td> </tr> <tr> <td>ERR</td> <td></td> <td>RDL</td> <td></td> </tr> </table>	PWR		RUN			green		green					ERR		RDL		<p>Non redundant device, ready.</p> <p>The device is operational; it is not part of a redundant set.</p> <p>Primary Device is redundant set.</p> <p>The device is operational, acting as Primary Device in a redundant set. The secondary device is ready</p>
PWR		RUN															
	green		green														
																	
ERR		RDL															
<table border="1"> <tr> <td>PWR</td> <td></td> <td>RUN</td> <td></td> </tr> <tr> <td></td> <td>green</td> <td></td> <td>green</td> </tr> <tr> <td></td> <td>red</td> <td></td> <td></td> </tr> <tr> <td>ERR</td> <td></td> <td>RDL</td> <td></td> </tr> </table>	PWR		RUN			green		green		red			ERR		RDL		<p>Permanent hardware fault detection during startup.</p> <p>A fatal error has been detected. Possible failure could be a missing Ethernet connection.</p>
PWR		RUN															
	green		green														
	red																
ERR		RDL															
<table border="1"> <tr> <td>PWR</td> <td></td> <td>RUN</td> <td></td> </tr> <tr> <td></td> <td>green</td> <td></td> <td>green</td> </tr> <tr> <td></td> <td>red</td> <td></td> <td></td> </tr> <tr> <td>ERR</td> <td></td> <td>RDL</td> <td></td> </tr> </table>	PWR		RUN			green		green		red			ERR		RDL		<p>Primary device or non-redundant device, hardware failure.</p> <p>The device is acting as non-redundant device, but a minor hardware failure has been detected during start-up.</p> <p>In the case of a Primary Device on a redundant set, the secondary device is not ready</p>
PWR		RUN															
	green		green														
	red																
ERR		RDL															
<table border="1"> <tr> <td>PWR</td> <td></td> <td>RUN</td> <td></td> </tr> <tr> <td></td> <td>green</td> <td></td> <td>green</td> </tr> <tr> <td></td> <td>red</td> <td></td> <td></td> </tr> <tr> <td>ERR</td> <td></td> <td>RDL</td> <td></td> </tr> </table>	PWR		RUN			green		green		red			ERR		RDL		<p>Primary device or non-redundant device, failure.</p> <p>The device is acting as non-redundant device, but a failure has been detected.</p> <p>or</p> <p>Secondary device, not ready.</p> <p>The device is acting as secondary device in a redundant set, but it is not ready to take over the primary role due to e.g. not synchronized configuration information or a non-operational redundancy link.</p> <p>or</p> <p>Primary Device or non-redundant device, failure.</p>
PWR		RUN															
	green		green														
	red																
ERR		RDL															

LEDs	Meaning		
	<p>The device is acting as Primary Device in a redundant set or as non-redundant device, but a failure has been detected.</p> <p>In the case of a Primary Device in a redundant set or as non-redundant set, the secondary device is not ready.</p>		
<table border="1" style="width: 100%; border-collapse: collapse;"> <tr> <td style="width: 50%; vertical-align: top;"> PWR  green  ERR </td> <td style="width: 50%; vertical-align: top;"> RUN  green  RDL </td> </tr> </table>	PWR  green  ERR	RUN  green  RDL	<p>Secondary device, operational.</p> <p>The device is operational as secondary device in a redundant set. The configuration information has been successfully transferred from the Primary Device and the redundancy link is operational.</p>
PWR  green  ERR	RUN  green  RDL		
<table border="1" style="width: 100%; border-collapse: collapse;"> <tr> <td style="width: 50%; vertical-align: top;"> PWR  green  ERR </td> <td style="width: 50%; vertical-align: top;"> RUN   RDL </td> </tr> </table>	PWR  green  ERR	RUN   RDL	<p>Secondary device, hardware failure.</p> <p>The device is acting as secondary device in a redundant set, but a hardware failure has been detected. Details are available on the web page Diagnostics³³ of the device.</p>
PWR  green  ERR	RUN   RDL		
<table border="1" style="width: 100%; border-collapse: collapse;"> <tr> <td style="width: 50%; vertical-align: top;"> PWR  green  ERR </td> <td style="width: 50%; vertical-align: top;"> RUN  green  RDL </td> </tr> </table>	PWR  green  ERR	RUN  green  RDL	<p>Primary with H1 error state</p>
PWR  green  ERR	RUN  green  RDL		
<table border="1" style="width: 100%; border-collapse: collapse;"> <tr> <td style="width: 50%; vertical-align: top;"> PWR  green  ERR </td> <td style="width: 50%; vertical-align: top;"> RUN  green  RDL </td> </tr> </table>	PWR  green  ERR	RUN  green  RDL	<p>Primary not ready</p>
PWR  green  ERR	RUN  green  RDL		
<table border="1" style="width: 100%; border-collapse: collapse;"> <tr> <td style="width: 50%; vertical-align: top;"> PWR  green  ERR </td> <td style="width: 50%; vertical-align: top;"> RUN  green  RDL </td> </tr> </table>	PWR  green  ERR	RUN  green  RDL	<p>Secondary with H1 error</p>
PWR  green  ERR	RUN  green  RDL		
<table border="1" style="width: 100%; border-collapse: collapse;"> <tr> <td style="width: 50%; vertical-align: top;"> PWR  green  ERR </td> <td style="width: 50%; vertical-align: top;"> RUN   RDL </td> </tr> </table>	PWR  green  ERR	RUN   RDL	<p>Primary, configuration error</p>
PWR  green  ERR	RUN   RDL		

8.4 Status indications of the four H1 channels

The following table shows the channel LEDs and their meaning for all four channels (CH1 - CH4):

Symbol	Color / frequency	Meaning
	green	Visitor address
	flashing slowly (0.5 Hz)	not in LAS role
	flashing quickly (5 Hz)	LAS role
	red	no carrier or H1 link is disconnected
	flashing red	no token received
	off	H1 link unused

9 Appendix

9.1 FOUNDATION Fieldbus basics

9.1.1 Link active scheduler

The link active scheduler (LAS) is a deterministic, centralized bus scheduler that controls the communication in the H1 segment. It is responsible to maintain the live list.

9.1.2 Visitor host

A visitor host is a secondary on-process host typically used for asset management and device maintenance. The visitor host uses CLT/SRV connections only. It usually should be assigned to node addresses in the range from 252 to 255.

9.1.3 Live list

The Live list is a list of all currently active devices.

9.1.4 Publisher/subscriber links (PUB/SUB links)

Publisher/subscriber links is used for cyclic transfer of process values (input data and output data). The process value is send by a publisher. Multiple subscribers linked to the publisher are able to receive the process value.

The LAS coordinates the cyclic data transfer on base of a synchronized system time. The cyclic data transfer is synchronized with the execution of the function blocks in the field devices. The schedules for cyclic data transfer as well as for the execution of the function blocks are generated by the comConf tool.

Input data

In case of input data the input function block executed and immediately after the function block execution the new data are transmitted over the line.

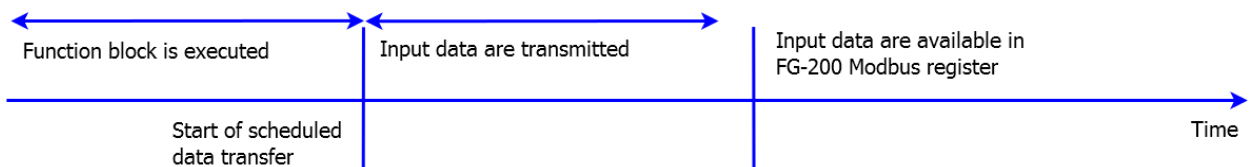

Output data

In case of output data the output function block is executed immediately after the transmission of the output data.

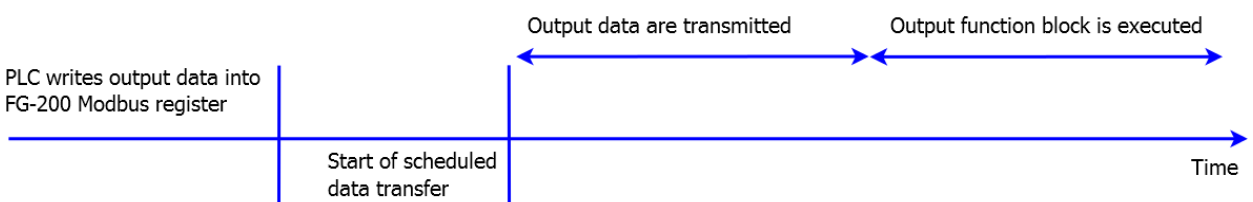

Output function blocks detect the absence of fresh PLC output data. If the PLC does not provide fresh output data then output function blocks will switch into a fault state mode. As the PLC write accesses to the FG-200 Modbus registers are not synchronized with the cyclic data transfer in the H1 segment it is necessary that the PLC writes "oversample" the H1 macrocycle. If, for example, the macrocycle time in the H1 link is one second then it is assumed that the PLC writes fresh output data every 500 milliseconds.

9.1.5 Client/server connections (CTL/SRV connections)

Client/server connections are used for acyclic transfer between FG-200 and field devices. Acyclic data transfer is performed in the gaps between cyclic data transfer. For client/server connections the client (FG-200) establishes and server (H1 field device) is established. Once the connection is established the FG-200 can send read and write requests to the field device. After processing the request the field device sends a read or write response to the FG-200.

In case of client/server communication the FG-200 build internal read lists with all parameters configured in the Modbus mapping table or in the point pages. The FG-200 executes this read lists periodically. The time for executing the read lists depends on various factors. As a rule of thumb you can assume that a read request and the corresponding read response will take about 100 millisecond. Thus, if you have, for example, 25 parameters in your Modbus mapping and/or in your point pages each Modbus register and point page parameter will be updated every two and a half second.

The main time consuming factors in read request handling are the low baud rate in an H1 segment (31.25 kbit/sec) and the processing time of the read request in the H1 field device. The processing time within the FG-200 is negligible. The FG-200 supports four H1 segments. If, enhancing the example above, 25 parameters are configured in each segment the update time of the $4 * 25$ parameters will still be two and a half second.

Please consider that the execution of the FG-200 read lists is not synchronized with the periodic execution of the function blocks. Assuming the function blocks are executed one time per second and the execution of the read list takes two and a half seconds then you will get only each second or third value produced by the function block.

9.1.6 Macrocycle

Macro cycle is the period of the function block schedule and the cyclic data transfer schedule. Typical macrocycle times are 500 milliseconds, one second, two seconds and four seconds.

9.1.7 Input/output parameters (I/O parameters)

Input and output parameters are used for accessing process values (input data and output data). They are structured parameters composed of a status and a value.

IO parameters are typically transmitted via publisher/subscriber links. If no publisher/subscriber links are configured IO parameter can be read and written via client/server connection.

9.1.8 Contained parameters

Contained parameters are used for data that are not process values. Contained parameters contain status information and configuration data.

Contained parameters are read or written via client/server connections. It is not possible to transmit contained parameters via publisher/subscriber links.

9.2 Redundancy

9.2.1 Redundancy behavior

The following table provides detailed information on the redundancy behavior. This may be useful to get a correct understanding of what fault conditions can be covered and how the system recovers from those fault conditions.

In any case, the fully redundant state is obtained again when the secondary device indicates "operational" (RUN-LED flashing) and its H1 live lists are complete. In highly populated, tightly configured H1 links it may take several minutes to acquire the live lists. Before the live lists are completed, redundancy switching is possible but client server connections can only be established to H1 devices which are in the live list.

Any further error that occurs before the fully redundant state is reached may cause the system to fail.

9.2.1.1 Primary device failure (1)

Primary device failure due to permanent or transient hardware or software fault (1):

Fault detection	Device fails completely or software watchdog expires or hardware watchdog expires or exception occurs or failure in H1 interface detected.
Fault treatment	Primary role actively transferred to or taken by redundant system
Effect	Redundancy switch-over. System degrades to non-redundant system.
Repair measure	Transient fault: Automatic reboot Permanent fault: replace device Secondary service will reboot and receive configuration data from primary device.

9.2.1.2 Ethernet cable broken (2)

Ethernet cable broken between primary device and Ethernet hub/switch (2)

Fault detection	Bad link status of Ethernet port detected. Detection time less than 500 ms.
Fault treatment	Primary role actively transferred to redundant device.
Effect	Redundancy switch-over. System degrades to non-redundant system.
Repair measure	Repair or reconnect Ethernet cable. Secondary device will reboot and receive configuration data from primary device.

9.2.1.3 H1 cable broken (3)

H1 cable broken between primary device and H1 network (3)

Fault detection	Empty live list detected on one H1 port or primary device while secondary device still has non-empty live list. Due to the H1 protocol it may take some seconds. Until the live list becomes empty. Detection occurs only if in primary device and secondary device the number of active H1 devices in the live list has exceeded the threshold of one.
Fault treatment	Primary role actively transferred to redundant device, so that access to H1 is possible again.
Effect	Redundancy switch-over. No redundancy concerning the affected H1 link.
Repair measure	Repair or reconnect H1 cable.

9.2.1.4 Secondary device failure (4)

Secondary device fails due to permanent or transient hardware or software fault (4)

Fault detection	Device fails completely or software watchdog expires or hardware watchdog expires or exception occurs or failure in H1 interface detected.
Fault treatment	Secondary device assumes and indicates non-operational state.
Effect	System degrades to non-redundant system.
Repair measure	Transient fault: Automatic reboot Permanent fault: replace device Secondary device will reboot and receive configuration data from primary device.

9.2.1.5 Ethernet cable broken (5)

Ethernet cable broken between secondary device and Ethernet hub/switch (5)

Fault detection	Bad link status of Ethernet port detected. Detection time less than 500 ms.
Fault treatment	Secondary device assumes and indicates non-operational state.
Effect	System degrades to non-redundant system.
Repair measure	Repair or reconnect Ethernet cable. Secondary device will reboot and receive configuration data from primary device.

9.2.1.6 H1 cable broken (6)

H1 cable broken between secondary device and H1 network (6)

Fault detection	No fault detection in secondary device. Empty live list has to be detected by any HSE client (e. g. asset monitor).
Fault treatment	None.
Effect	No redundancy concerning the affected H1 link.
Repair measure	Repair or reconnect H1 cable.

9.2.1.7 TCP connection lost (7)

TCP connection lost between primary device and secondary device (7)

Fault detection	Time-out on TCP connection. Detection time less than 2 sec during activity and less than 7 sec during idle times.
Fault treatment	Secondary device assumes and indicates non operational state ¹ .
Effect	System degrades to non-redundant system. Secondary device clears configuration.
Repair measure	Repair Ethernet connection.

	Secondary device may reboot in some cases depending on prior state and will receive configuration data from primary device.
--	---

1) If the secondary device reboots cyclically in this state, set the TCP acknowledge timeout (object 22223) to a smaller value.

9.2.1.8 Redundancy link broken or removed (8)

Redundancy link broken or removed between primary device and secondary device (8)

Fault detection	Loss of serial communication. Detection time less than 800 ms.
Fault treatment	Secondary device assumes and indicates non operational state.
Effect	System degrades to non-redundant system.
Repair measure	Repair or reconnect redundancy link. Secondary device will reboot and receive configuration data from primary device.

9.2.1.9 State indication associated

The following table shows the state indications associated with the fault states described above. The numbers in the first column refer to the previous table. Line 0 describes the faultless state. "primary device" and "secondary device" denote the role after redundancy switching.

	Primary device			Secondary device		
	R-LED	H1-LED	Web-Info	R-LED	H1-LEDs	Web-Info
0	On	fast on configured links Off on unconfigured links.	Ok Primary	Flashing	Slow on configured links Off on not configured links	Ok Secondary
1	On	fast on configured links Off on not configured links	Failure no serial communication Primary, no backup	off	off	(no connection to web server)
2	On	fast on configured links Off on non configured links	Failure TCP link to redundant device is lost Primary, no backup	Flashing	Slow on configured links Off on non configured links	(no connection to web server)
3	On	fast on configured links Off on not configured links	Ok Primary	Flashing	fast on missing links Slow on configured links	Ok Secondary

	Primary device			Secondary device		
	R-LED	H1-LED	Web-Info	R-LED	H1-LEDs	Web-Info
					Off on not configured links	
4	On	fast on configured links Off on not configured links	Failure no serial communication Primary, no backup	off	off	(no connection to web server)
5	On	fast on configured links Off on not configured links	Failure TCP link to redundant device is lost Primary, no backup	Flashing	Slow on configured links Off on not configured links	(no connection to web server)
6	On	fast on configured links Off on not configured links	Ok Primary	Flashing	fast on missing links Slow on configured links Off on not configured links	Ok Secondary
7	On	fast on configured links Off on not configured links	Failure TCP link to redundant device is lost Primary, no backup (if connection to web server possible)	off	off	Failure TCP link to redundant device is lost Primary, no backup (if connection to web server possible)
8	On	fast on configured links Off on not configured links	Failure no serial communication Primary, no backup	off	Slow on configured links Off on not configured links	Failure no serial communication Primary, no backup

9.2.2 Duration of redundancy switch-over

Switch-over duration PUB/SUB links

During redundancy switch-over, the activity on H1 links is interrupted. From the perspective of a single H1 device, [PUB/SUB links](#)⁶² are interrupted for a period of time that is composed of the following times:

- fault detection time t_{fd}
- redundancy switching time t_{rs}
- macro cycle duration t_{mc}

The time of inactivity due to redundancy switch-over for a single process value is therefore:

- time of inactivity $= t_{fd} + t_{rs} + t_{mc}$
- compared to t_{mc} during regular operation.

The fault detection time is:

- $t_{fd} = 800$ ms if the primary device fails.
- $t_{fd} = 1500$ ms if the Ethernet connection on the primary device is removed.

The redundancy switching time is:

- $t_{rs} = 500$ ms.

The macrocycle duration depends on the configuration and is usually in the range of 500 ms to 2 seconds.

Switch-over duration for CLT/SRV connections

In case of [CLT/SRV connections](#)⁶³ the switch will take about one minute.

If [contained parameters](#)⁶³ such as BLOCK_ERR or channel are accessed, it will take about one minute until the registers in the secondary FG-200 show the current parameter values.

9.2.3 Replace a defective FG-200 in a redundant set

For replacing a defective FG-200 in a redundant set of FG-200s, perform the following steps:

1. Identify the defective FG-200. Refer to [Status indicators - LEDs](#) ⁽⁵⁷⁾.
2. Remove the power terminal block from the FG-200.
3. Remove the redundancy link interface cable and the Ethernet cable.
4. If not indicated on the cable, make a note to which channel each H1 link is connected. Then remove the H1 terminal blocks.
5. Make sure that the new FG-200 has the same IP configuration (IP address and subnet mask) as the replaced defective device. See [Internet Protocol submenu](#) ⁽³⁸⁾ for more information.
6. Replace the defective FG-200.
7. Plug in the H1 terminal blocks. Make sure to use the same allocation as before.
8. Connect the Ethernet cable and the redundancy link interface cable.
9. Make sure that the redundancy link interface cable is connected before plugging in the power terminal block.

If the replaced FG-200 is powered while the serial link is missing, it will behave like an independent, non-redundant primary device. If in this case the FG-200 has a valid (possibly unknown) configuration, it might use H1 node addresses which are already in use on the H1 links. This will disturb or interrupt communication and application processing on the H1 links.

10. Plug in the power terminal block. The boot process and the download of the configuration information take about 1 minute. For indication of proper operation as a secondary device refer to [Status indicators - LEDs](#) ⁽⁵⁷⁾.

9.3 Diagnostics - Advanced submenus

Click **Advanced** to open the following submenus:

9.3.1 Fieldbus Statistics submenu

This table shows you information about all four segments concerning

- Live List Changes - number of total live list changes
- Live List Pass Token Timeouts - number of pass token timeouts; under good conditions it should be "0"
- Total Retries - number of total retries for acyclic H1 requests. This could be an indication of noise on the H! segment or a H1 device problem.
- Messages Transmitted - number of messages transmitted by the FG-200.
- Good Messages Received - number of messages received from FG-200.

The button **[Reset Statistic Counter]** allows you to reset all segment values to zero and to restart counting. To see the new results, click **Fieldbus Statistics** again.

Diagnostics > Advanced > Fieldbus Statistics

Description	Segment 1	Segment 2	Segment 3	Segment 4
Live List Changes	0	0	0	4
Live List Pass Token Timeouts	0	0	0	0
Total Retries	0	0	0	0
Messages Transmitted	0	0	0	999566
Good Messages Received	0	0	0	395088

Reset Statistic Counter

Last Reset: Fri Sep 18 2015 10:12:01 GMT+0200

9.3.2 HSE Statistics submenu

This table shows you the total number and number per second of HSE frames grouped into:

- Publisher / Subscriber
- Report Distribution
- Client / Server
- System Management
- Redundancy Synchronization

(This functionality is not supported by AssetMonitor Linking Devices.)

The button **[Reset Statistic Counter]** allows you to reset all segment values to zero and to restart counting. To see the new results, click **[Fieldbus Statistics]** again.

Diagnostics > Advanced > HSE Statistics

Description	Total	Per Second
Publisher / Subscriber	186837	3
Report Distribution	0	0
Client / Server	295	0
System Management	215	0
Redundancy Synchronization	0	0

Reset Statistic Counter

Last Reset: Thu Sep 17 2015 15:38:49 GMT+0200

9.3.3 FPGA Error Statistics submenu

This table shows the values of the framing error counters per channel and checksum errors in received packets. High counter values may indicate a bad signal quality in the H1 channel and/or a device that is not operating properly.

In addition, the following information is displayed:

- Framing Errors (i.e. incomplete frames, might be an indication of noise on the H1 segment)
- Checksum Errors (might be an indication of noise on the H1 segment)
- Carrier Not Seen Errors
- Buffer Not Empty (might indicate that the H1 network is not connected or not powered)
- Receive Overrun
- Transmit Overrun
- Transmit Readback Error
- Collision Timeout Errors (might indicate that the H1 network is not connected or not powered).

Diagnostics > Advanced > FPGA Error Statistics

Description	Segment 1	Segment 2	Segment 3	Segment 4
Framing Errors	0	0	0	0
Checksum Errors	0	0	0	0
Carrier Not Seen Errors	0	0	0	0
Buffer Not Empty	0	0	0	0
Receive Overrun	0	0	0	0
Transmit Overrun	0	0	0	0
Transmit Readback Error	0	0	0	0
Collision Timeout Errors	0	0	0	0

9.3.4 FPGA Register Contents submenu

The content of the FPGA register contains data which is only relevant if you contact Softing's customer support for error analysis and troubleshooting.

If requested by Softing's support, take a screen shot and send your problem description together with the screen shot to support.automation@softing.com.

9.3.5 Device Temperature submenu

This table shows you information about current temperature values in degrees Celsius and Fahrenheit.

The button **[Reset Temperature Values]** allows you to reset all values to zero and to restart measuring. To see the new results, click **[Device Temperature]** again.

Diagnostics > Advanced > Device Temperature

Description	Celsius	Fahrenheit	Time
Current Temperature	47.500	117.500	2015/08/27 16:08:08
Min. Temperature (Lifetime)	21.500	70.700	1972/01/01 01:00:00
Max. Temperature (Lifetime)	54.500	130.100	1972/01/01 01:00:00
Min. Temperature	47.500	117.500	2015/08/27 16:08:05
Max. Temperature	47.500	117.500	2015/08/27 16:08:05

Reset Temperature Values

9.3.6 Modbus Statistics submenu

The Modbus communications statistics provide information on the data and packets received and transmitted by the Modbus slave interface.

- **[Serial]** for monitoring the Modbus link
- **[TCP]** for monitoring the Modbus TCP/IP communications

Serial

The menu item **Serial** shows statistical data of a Modbus connected on a serial interface. First messages and CRC errors from received data are listed. Then messages and error responses from the transmitted data are listed.

The values specified apply to the time since the program has been started or the latest **[Reset Statistic Counter]**.

Diagnostics > Advanced > Modbus Statistics > Serial

Description	Values
Messages Received	0
CRC Errors	0
Messages Transmitted	0
Error Responses	0

Reset Statistic Counter

Last Reset: Thu Sep 10 2015 12:57:02 GMT+0200

The button **[Reset Statistic Counter]** allows you to reset all values to zero and to restart counting. To see the new results, click **[Serial]** again.

TCP

The menu item **TCP** shows statistical data of a Modbus connected using TCP. First received and transmitted messages are listed. Then the error responses are counted. Finally open and accepted connections are listed.

The button **[Reset Counts]** allows you to reset all values to zero and to restart counting. To see the new results, click **[TCP]** again.

Diagnostics > Advanced > Modbus Statistics > TCP

Description	Values
Messages Received	1666
Messages Transmitted	1666
Error Responses	0
Open Connections	0
Accepted Connections	3

Reset Statistic Counter

Last Reset: Thu Sep 10 2015 12:57:04 GMT+0200

9.4 Coding of bit fields

Parameter BLOCK_ERR

No error	0x0000
Out Of Service	0x0001
Power up	0x0002
Device needs maintenance	0x0004
Readback check failed	0x0008
Lost nv data	0x0010
Lost static data	0x0020
Memory failure	0x0040
Output failure	0x0080
Input failure	0x0100
Dev needs maint soon	0x0200
Dev fault state set	0x0400
Local override	0x0800
Simulate active	0x1000
Link config err	0x2000
Block config err	0x4000
Other	0x8000

Parameter MODE_BLK:

Out Of Service	0x01
Initialization Manual	0x02
Local Override	0x04
Manual	0x08
Auto	0x10
Cascade	0x20
Remote-Cascade	0x40
Remote-Output	0x80

Modbus Register 16 Bit register contains target mode in High Byte, actual mode in low byte.

Example: Modbus value 0x1001 means: target mode = Auto, actual mode = Out Of Service

Field Diagnostics (Parameter FD_FAIL, FD_OFFSPEC, FD_CHECK, FD_MAINT)

The bit fields are vendor specific and not specified by FIELDBUS Foundation except the least significant bit (LSB). The LSB indicates the check function to be active. The check function is typically mapped to the FD_CHECK parameter but may also be mapped to any of the other FD_xxx parameters.

The value for LSB is 0x80000000, the value for the most significant bit (MSB) is 0x00000001.

9.5 Modbus exception responses

ExceptionCode = 02

The FG-200 will send an exception response with [ExceptionCode = 02] if [start address] or [start address + quantity of registers] is not OK.

ExceptionCode = 04

The FG-200 will send an exception response with [ExceptionCode = 04] if one of the requested registers does not contain valid data. Please note that after power-on the FG-200 responds with [ExceptionCode = 04] until all requested data are read from the connected H1 field devices.

9.6 Assign a second (local) IP address under Windows 8.1

1. Open the **Desktop**.
2. Press the **Windows start key** and select **Control Panel**.
3. Select **Network and Internet**.
4. Open **Network and Sharing Center**.
5. Click **Connections**.
6. In the Connection Status window click **Properties**.
7. In the item connection list select **Internet Protocol Version 4 (TCP/IPv4)**.
8. Click **Properties**. In the **General** dialog, the regular (first) IP address, the subnet mask and the standard gateway are shown.
9. Click **Advanced** to add a second IP address. Then click **[Add]** in the IP Addresses dialog.
10. Enter the IP address and the subnet mask.
11. Click **[Add]**.
12. Then confirm all open dialogs with **[OK]**.

10 ATEX Type Examination Certificate



1 **Translation**
Type Examination Certificate
Supplement 1
Change to Directive 2014/34/EU

2 Equipment intended for use in potentially explosive atmospheres
 Directive 2014/34/EU

3 Type Examination Certificate Number: **BVS 15 ATEX E 063 X**

4 Product: **Linking Device type FG-200 HSE/FF**

5 Manufacturer: **Softing Industrial Automation GmbH**

6 Address: **Richard-Reitzner-Allee 6, 85540 Haar, Germany**

7 This supplementary certificate extends Type Examination Certificate No. BVS 15 ATEX E 063 X to apply to products designed and constructed in accordance with the specification set out in the appendix of the said certificate but having any variations specified in the appendix attached to this certificate and the documents referred to therein.

8 DEKRA Testing and Certification GmbH certifies that this product has been found to comply with the Essential Health and Safety Requirements relating to the design and construction of products intended for use in potentially explosive atmospheres given in Annex II to the Directive. The examination and test results are recorded in the confidential Report No. PP 15.2105 EU.

9 The Essential Health and Safety Requirements are assured in consideration of:

EN IEC 60079-0:2018	General requirements
EN IEC 60079-7:2015+A1:2018	Increased Safety "e"
EN 60079-11:2012	Intrinsic Safety "i"

10 If the sign "X" is placed after the certificate number, it indicates that the product is subject to the Special Conditions for Use specified in the appendix to this certificate.

11 This Type Examination Certificate relates only to the design and construction of the specified product. Further requirements of the Directive apply to the manufacturing process and supply of this product. These are not covered by this certificate.

12 The marking of the product shall include the following:

 **II 3G Ex ec IIC T4 Gc**
II 3G Ex ec [ic] IIC T4 Gc

DEKRA Testing and Certification GmbH
 Bochum, 2021-08-11

Signed: Jörg-Timm Kilisch

 Managing Director



Page 1 of 3 of BVS 15 ATEX E 063 X / N1 – Jobnumber 342377300
 This certificate may only be reproduced in its entirety and without any change.
 DEKRA Testing and Certification GmbH, Handwerkstr. 15, 70565 Stuttgart, Germany
 Certification body: Dinnendahlstr. 9, 44809 Bochum, Germany
 Phone +49.234.3696-400, Fax +49.234.3696-401, e-mail DTC-Certification-body@dekra.com



13 **Appendix**
 14 **Type Examination Certificate**

**BVS 15 ATEX E 063 X
 Supplement 1**

15 **Product description**

15.1 **Subject and type**

Linking Device type FG-200 HSE/FF

15.2 **Description**

With this supplement the certificate is changed to Directive 2014/34/EU.
 (Annotation: In accordance with Article 41 of Directive 2014/34/EU, EC-Type Examination Certificates referring to 94/9/EC that were in existence prior to the date of application of 2014/34/EU (20 April 2016) may be referenced as if they were issued in accordance with Directive 2014/34/EU. Supplementary Certificates to such EC-Type Examination Certificates, and new issues of such certificates, may continue to bear the original certificate number issued prior to 20 April 2016.)

The linking device acts as a gateway between Ethernet-based host systems with foundation field-bus HSE and the foundation field-bus H1 bus system. It is suited for network configuration, device parametrization and the recording of production data. The data circuits are galvanically isolated.

The Fieldbus circuits may operate as intrinsically safe circuits (level of protection Ex ic) or as non-intrinsically safe circuits; details see manual.

Reason for this supplement:

- Change to Directive 2014/34/EU
- Updating of the standards and the resulting change in the marking

15.3 **Parameters**

15.3.1 **Electrical parameters**

15.3.1.1 **Power supply circuit (terminals 1 – 3 or Rail Power Supply L+ and GND)**

Nominal voltage		DC	18...32	V
Power consumption			< 5.6	W
Max. voltage	U _m	DC	40	V

15.3.1.2 **Redundancy Link circuit (terminals 4,5,6)**

Nominal voltage		DC	up to 32	V
Max. voltage	U _m	DC	40	V

15.3.1.3 **Ethernet Ports (connectors ETH1, ETH2)**

Nominal voltage		DC	up to 32	V
Max. voltage	U _m	DC	40	V

15.3.1.4 **Fieldbus circuits (terminals 7,8,9 and 10,11,12 and 13,14,15 and 16,17,18)
 (if operated as non-intrinsically safe circuits)**

Nominal voltage		DC	24/32	V
-----------------	--	----	-------	---

(if operated as intrinsically safe circuits, each channel)

Voltage	U _i	DC	32	V
Current	I _i		570	mA

15.3.2 **Ambient temperature range**

-40 °C ≤ T_a ≤ see manufacturer's instructions



Page 2 of 3 of BVS 15 ATEX E 063 X / N1 – Jobnumber 342377300
 This certificate may only be reproduced in its entirety and without any change.

DEKRA Testing and Certification GmbH, Handwerkstr. 15, 70565 Stuttgart, Germany
 Certification body: Dinnendahlstr. 9, 44809 Bochum, Germany
 Phone +49.234.3696-400, Fax +49.234.3696-401, e-mail DTC-Certification-body@dekra.com



15.3.2.1 Horizontal installation position

Minimum distance	Maximum number of fieldbus channels used per device	Maximum voltage of fieldbus circuits	Maximum permissible ambient temperature T_a
0 mm	4	32 VDC	55 °C
0 mm	2	24 VDC	60 °C
17.5 mm	4	32 VDC	65 °C
17.5 mm	2	24 VDC	70 °C

15.3.2.2 Vertical installation position

Minimum distance	Maximum number of fieldbus channels used per device	Maximum voltage of fieldbus circuits	Maximum permissible ambient temperature T_a
0 mm	4	32 VDC	40 °C
0 mm	2	24 VDC	50 °C
17.5 mm	4	32 VDC	55 °C
17.5 mm	2	24 VDC	60 °C

16 Report Number

BVS PP 15.2105 EU, as of 2021-08-11

17 Special Conditions for Use

- 17.1 Transient protection shall be provided that is set at a level not exceeding 140 % of the peak rated voltage value at the supply terminals to the equipment.
- 17.2 The equipment has to be installed in a protective enclosure which meets the requirements for resistance to impact and IP54 defined in EN 60079-0 clause 26.4.
- 17.3 Before the first use of the device one marking field (Ex ec IIC T4 Gc or Ex ec [ic] IIC T4 Gc) has to be selected and marked; once the device has operated at non-intrinsically safe fieldbus circuits it may not operate at intrinsically safe fieldbus circuits without reconsideration by the manufacturer.
- 17.4 The ambient temperature range depends on various installation conditions of the devices; see manufacturer's instructions.
- 17.5 The equipment shall only be used in an area of at least pollution degree 2, as defined in IEC 60664-1.

18 Essential Health and Safety Requirements

The Essential Health and Safety Requirements are covered by the standards listed under item 9.

19 Drawings and Documents

Drawings and documents are listed in the confidential report.

We confirm the correctness of the translation from the German original.
In the case of arbitration only the German wording shall be valid and binding.

DEKRA Testing and Certification GmbH
Bochum, 2021-08-11
BVS-Pe/Mu A20210732

Managing Director



Page 3 of 3 of BVS 15 ATEX E 063 X / N1 – Jobnumber 342377300
This certificate may only be reproduced in its entirety and without any change.

DEKRA Testing and Certification GmbH, Handwerkstr. 15, 70565 Stuttgart, Germany
Certification body: Dinnendahlstr. 9, 44809 Bochum, Germany
Phone +49.234.3696-400, Fax +49.234.3696-401, e-mail DTC-Certification-body@dekra.com

11 UL Certificate of Compliance

CERTIFICATE OF COMPLIANCE

Certificate Number 20151215-E356500
Report Reference E356500-20151214
Issue Date 2015-DECEMBER-15

Issued to: SOFTING AG
 RICHARD-REITZNER-ALLEE 6
 85540 HAAR GERMANY

**This is to certify that
 representative samples of**

PROGRAMMABLE CONTROLLERS FOR USE IN
 HAZARDOUS LOCATIONS
 Class I, Division 2 Groups A,B,C and D.

Enclosed Type Fieldbus Gateways Model – FG-200
 HSE/FF

Have been investigated by UL in accordance with the
 Standard(s) indicated on this Certificate.

Standard(s) for Safety:

ANSI/ISA 12.12.01, Nonincendive Electrical Equipment for
 Use in Class I and II, Division 2 and Class III, Divisions 1
 and 2 Hazardous (Classified) Locations
 CAN/CSA C22.2 No. 213-15, Non-Incendive Electrical
 Equipment for Use in Class I, Division 2 Hazardous
 Locations

Additional Information:

See the UL Online Certifications Directory at
www.ul.com/database for additional information

Only those products bearing the UL Certification Mark should be considered as being covered by UL's
 Certification and Follow-Up Service.

Look for the UL Certification Mark on the product.

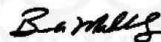

Bruce Mährenholz, Director North American Certification Program
 UL LLC

Any information and documentation involving UL Mark services are provided on behalf of UL LLC (UL) or any authorized licensee of UL. For questions, please
 contact a local UL Customer Service Representative at <http://ul.com/aboutul/locations>.



12 Declarations of conformity

This device is compliant with EC directive 2014/30/EG, "Electromagnetic Compatibility" (EMC directive) and meets the following requirements:

- EN 55011 Industrial, scientific and medical (ISM) devices - radio disturbance - limits and methods of measurement
- EN 55032 Electromagnetic compatibility of multimedia equipment (MME) and interference emission
- EN 61000-6-4 Electromagnetic compatibility (EMC); Part 6-4: generic standard – emission for industrial environments
- EN 61000-6-2 Electromagnetic compatibility (EMC); Part 6-2: generic standard - immunity for industrial environments



Note

To fulfill the EMC requirements, the other components of your installation (DC adapter, Industrial Ethernet devices, etc.) also have to meet the EMC requirements. A shielded cable must be used. In addition, the cable shield must be grounded properly.



CAUTION

This is a Class A product. In a domestic environment this product may cause radio interference in which case the user may be required to take adequate measures!



CE

A Declaration of Conformity in compliance with the above standards has been made and can be requested from Softing Industrial Automation.



ROHS

This product is ROHS compliant.



FCC

This equipment has been tested and found to comply with the limits for a Class A digital device, under part 15 of the FCC Rules. These limits are designed to provide reasonable protection against harmful interference when the equipment is operated in a commercial environment. This equipment generates, uses, and can radiate radio frequency energy and, if not installed and used in accordance with the instruction manual, may cause harmful interference to radio communications.



VCCI

This Class A product conforms to the regulations of Voluntary Control Council for Interference (VCCI) by Information Technology Equipment.



WEEE

Electrical and electronic equipment must be disposed of separately from normal waste at the end of its operational lifetime. Packaging material and worn components shall be disposed of according to the regulations applicable in the country of installation.

EU-Konformitätserklärung EU Declaration of Conformity



Wir
We

Softing Industrial Automation GmbH
Richard-Reitzner-Allee 6
D-85540 Haar

erklären hiermit in alleiniger Verantwortung, dass das Produkt
declare under our sole responsibility that the product

Modell / Typ
Model / Type

FG-200 HSE/FF (GLA-EK-024102) V1.01 / V1.02
FG-200 HSE/FF (GLA-EK-024103) V1.01 / V1.02

mit den Anforderungen der folgenden Richtlinien übereinstimmt
complies with the requirements of the following directives:

ATEX-Richtlinie 2014/34/EU

ATEX directive 2014/34/EU

EMV Richtlinie 2014/30/EU

EMC directive 2014/30/EU

ROHS-Richtlinie 2011/65/EU, ergänzt um Delegierte Richtlinie (EU) 2015/863

ROHS directive 2011/65/EU, amended by commission delegated directive (EU) 2015/863

Angewandte harmonisierte Normen
Applied harmonised standards:

EN IEC 60079-0:2018
EN 60079-11:2012
EN IEC 60079-7:2015/A1:2018
EN 55011:2016, Class A
EN 55032:2015
EN IEC 61000-6-2:2019
EN IEC 61000-6-4:2019
EN IEC 63000:2018

Haar, 9.6.2022

Ort, Datum
Place, Date

Geschäftsführer
Managing Director

Softing Industrial Automation GmbH

Richard-Reitzner-Allee 6
85540 Haar / Germany
<https://industrial.softing.com>

☎ + 49 89 45 656-340

✉ info.automation@softing.com

